

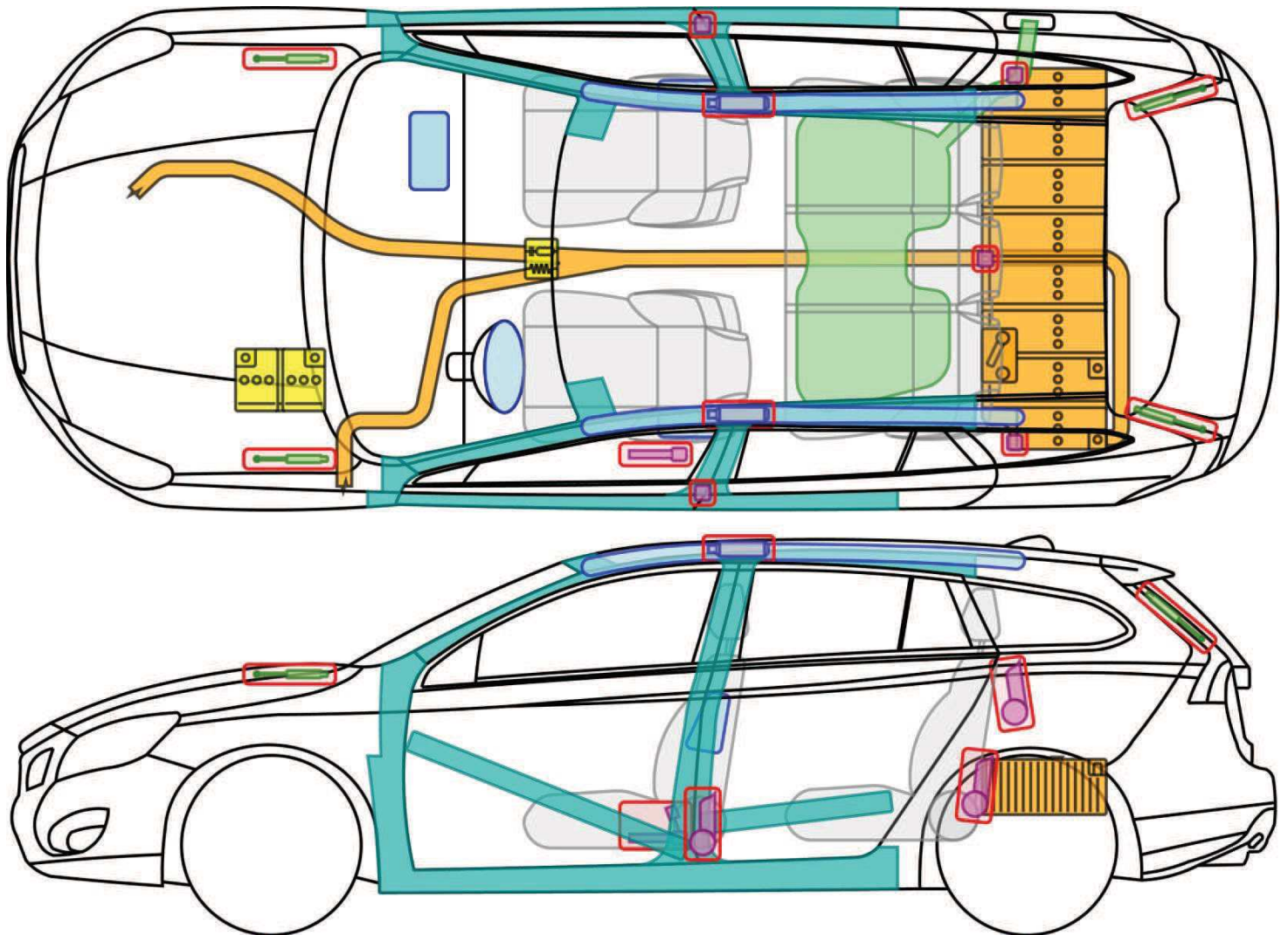

# VOLVO V60 PLUG-IN HYBRID (TYP F, 2012-)



## Legende







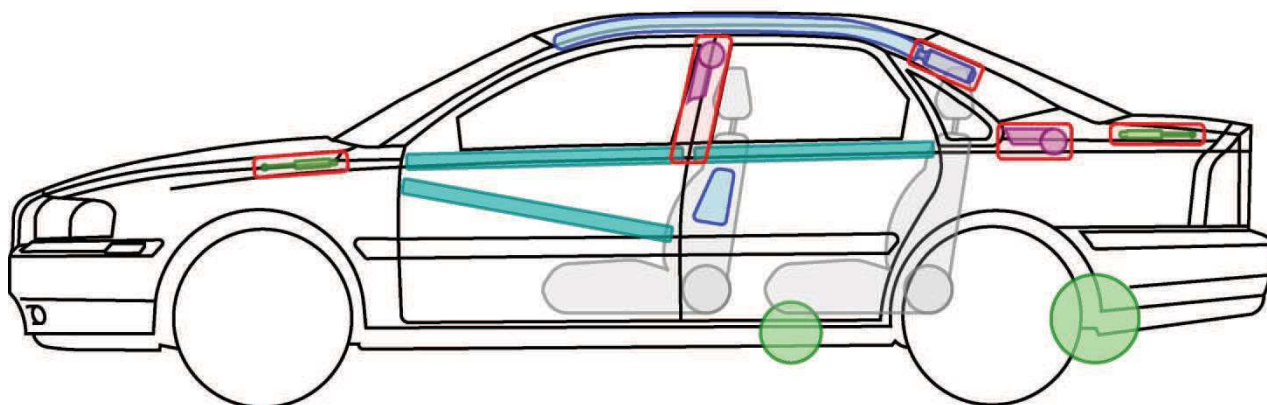
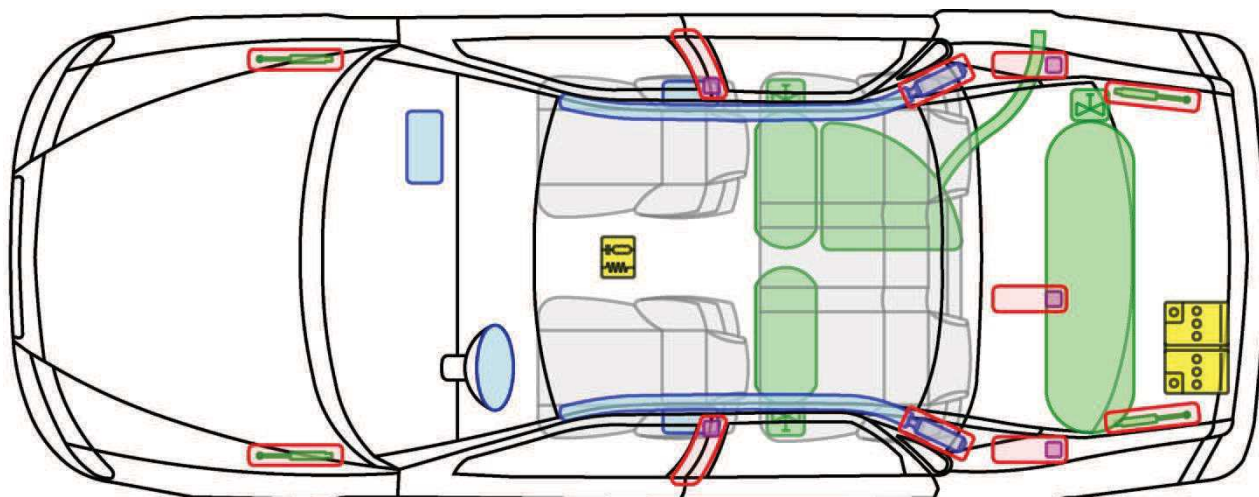

	Airbag		Karosserie- verstärkung		Steuergerät		mech. Sensor		Hochvolt- batterie
	Gas- generator		Überroll- schutz		Batterie		Gas-tank		Hochvolt- leitung/ -komponente
	Gurt- straffer		Gasdruck- dämpfer		Kraftstoff- tank		Sicherheits- ventil		HV- Trennstelle

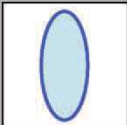
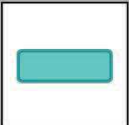

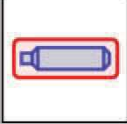
# VOLVO S80 BI-FUEL (TYP K, 1999-2006)

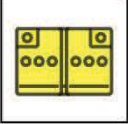

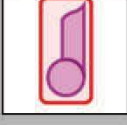
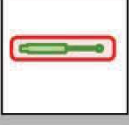
## Legende

	Airbag		Karosserie- verstärkung		Steuergerät		mech. Sensor
	Gas- generator		Überroll- schutz		Batterie		Gastank
	Gurt- straffer		Gasdruck- dämpfer		Kraftstoff- tank		Sicherheits- ventil



# VOLVO S90 T8 TWIN ENGINE (TYP P, 2017-)

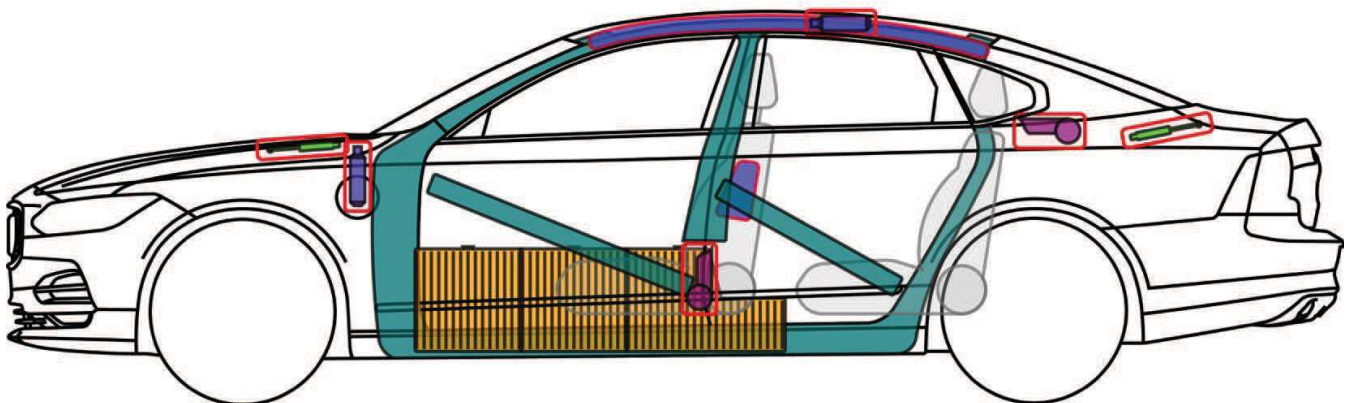
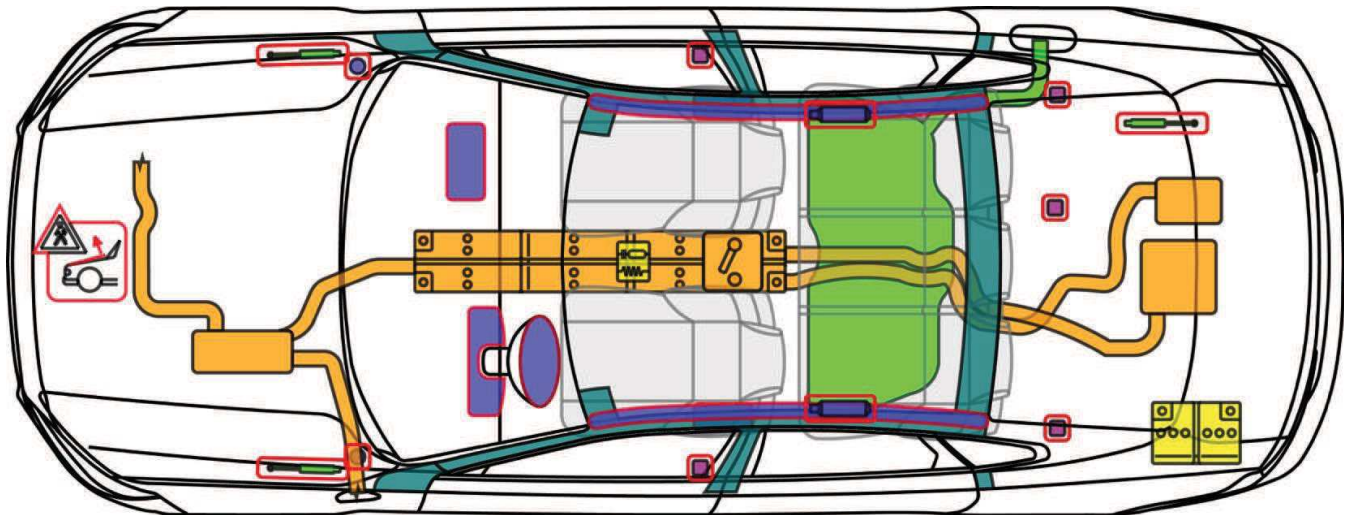

## Legende







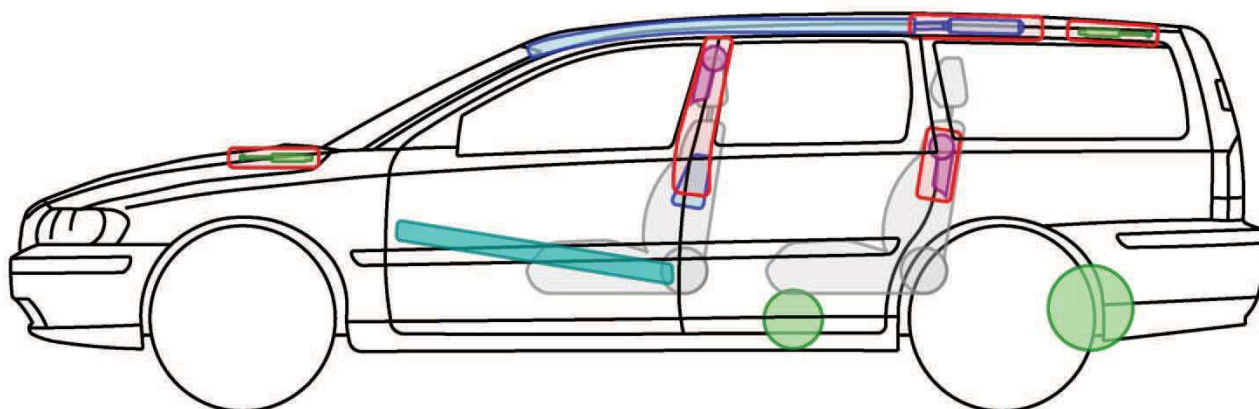
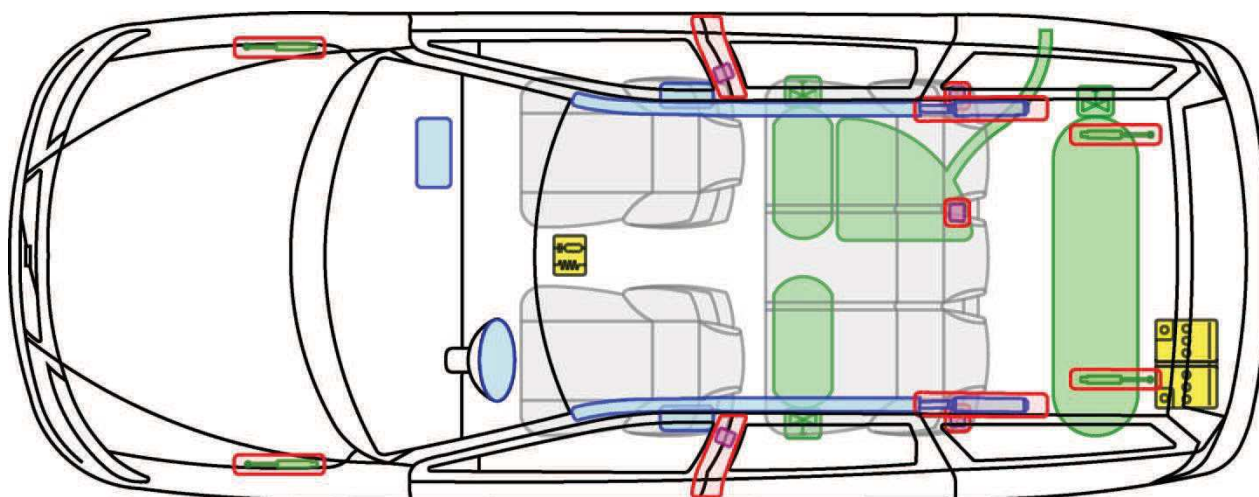

	Airbag		Karosserie-verstärkung		Steuergerät		Hochvolt-batterie
	Gas-generator		Überroll-schutz		Batterie		Hochvolt-leitung/-komponente
	Gurt-straffer		Gasdruck-dämpfer		Kraftstoff-tank		HV-Trennstelle

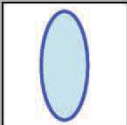
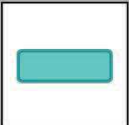

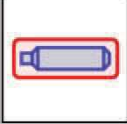
# VOLVO V70 BI-FUEL (TYP J, 2000-2007)

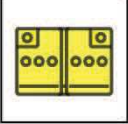

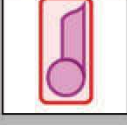
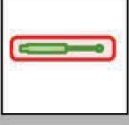
## Legende

	Airbag		Karosserie- verstärkung		Steuergerät		mech. Sensor
	Gas- generator		Überroll- schutz		Batterie		Gastank
	Gurt- straffer		Gasdruck- dämpfer		Kraftstoff- tank		Sicherheits- ventil



# VOLVO S90 T8 TWIN ENGINE (TYP P, 2017-)

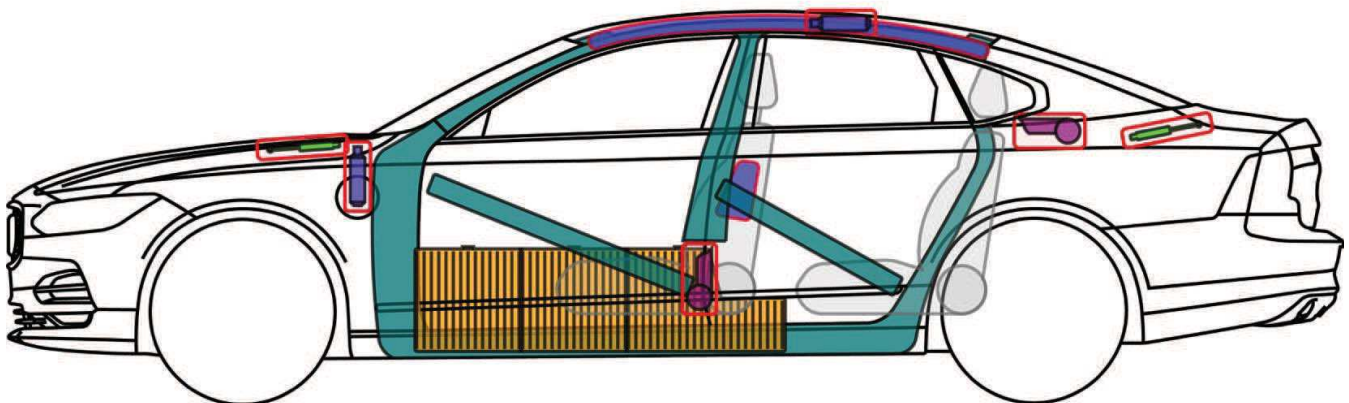
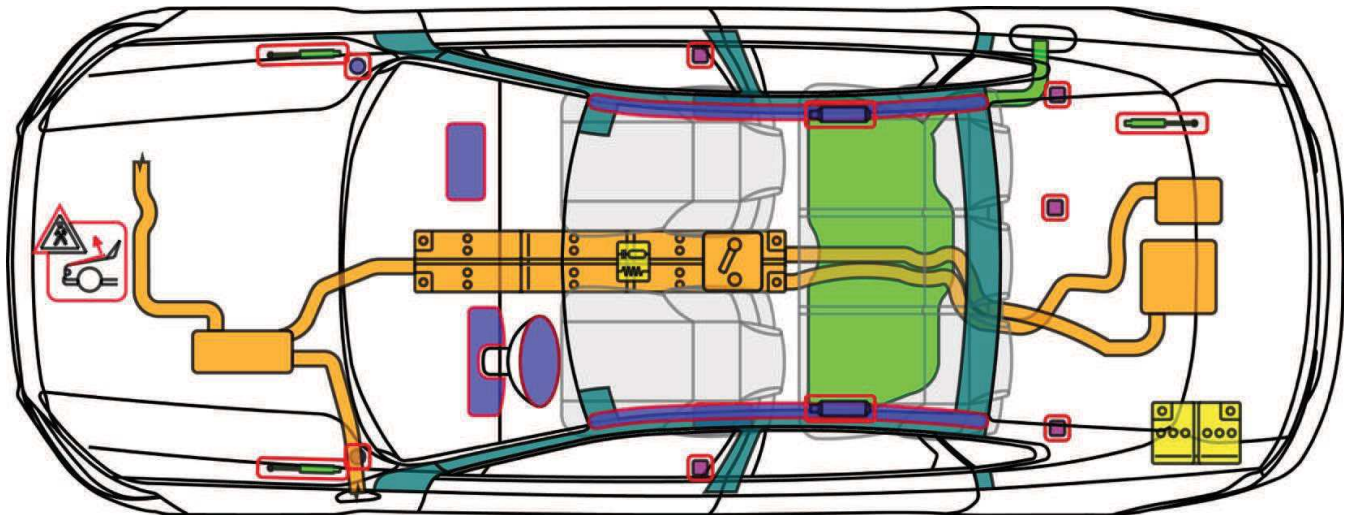

## Legende

	Airbag		Karosserie-verstärkung		Steuergerät		Hochvolt-batterie
	Gas-generator		Überroll-schutz		Batterie		Hochvolt-leitung/-komponente
	Gurt-straffer		Gasdruck-dämpfer		Kraftstoff-tank		HV-Trennstelle



# VOLVO V60 PLUG-IN HYBRID (TYP F, 2012-)

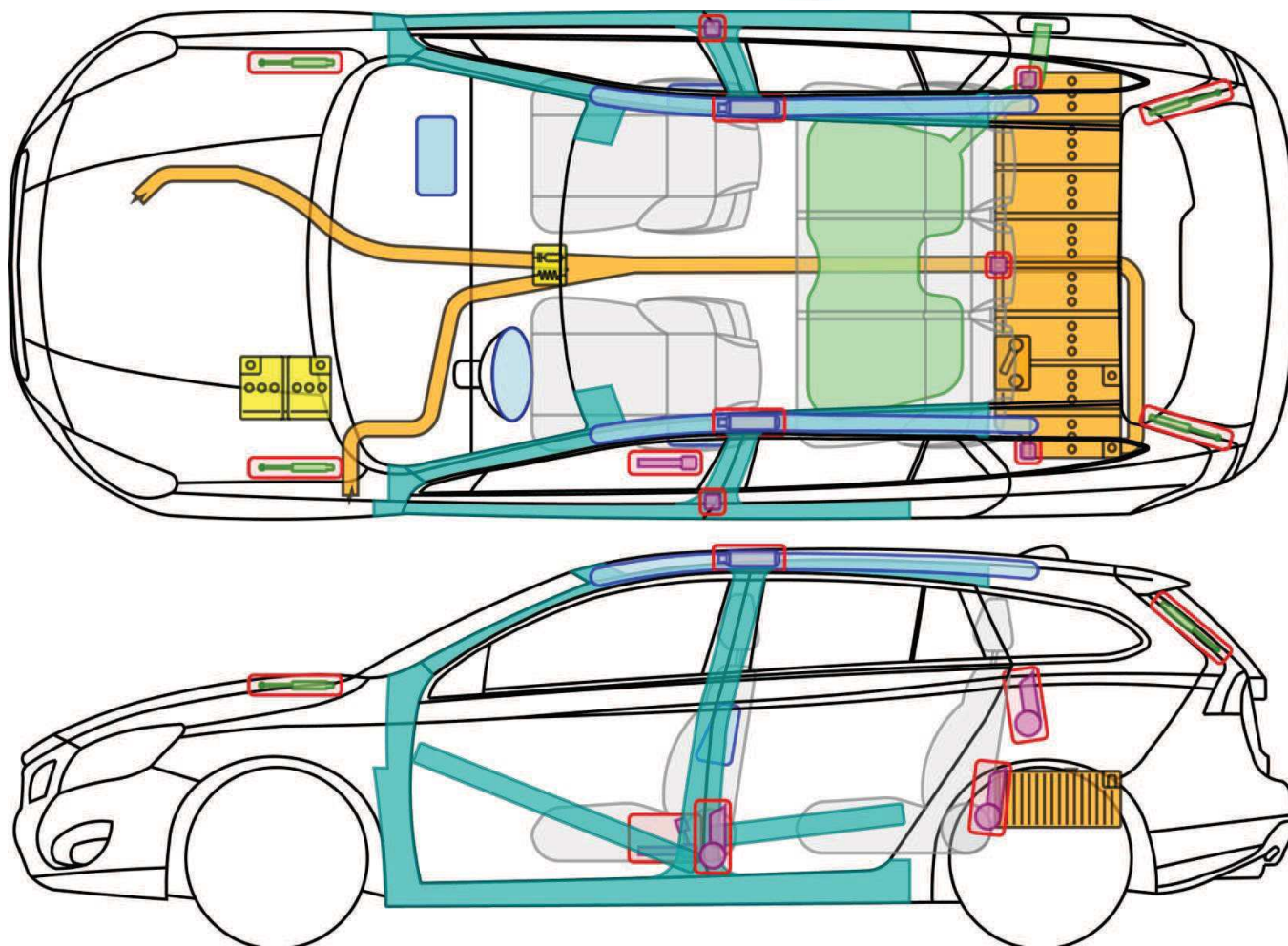

## Legende







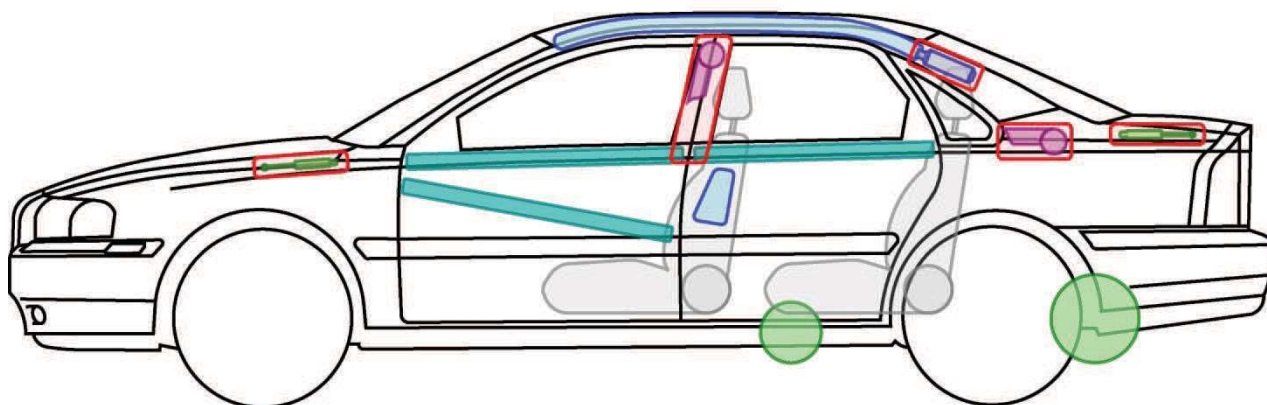
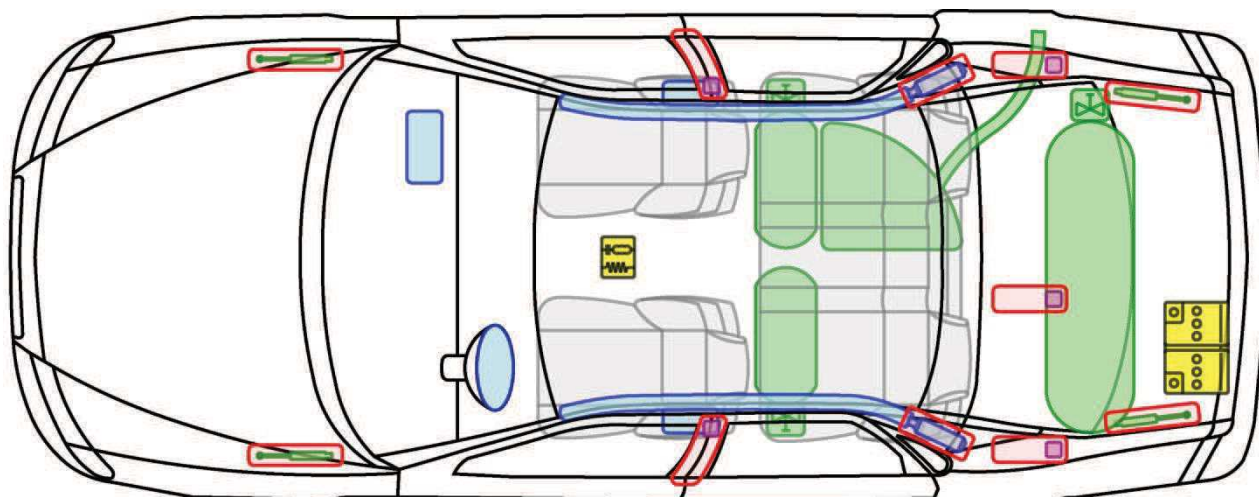

	Airbag		Karosserie- verstärkung		Steuergerät		mech. Sensor		Hochvolt- batterie
	Gas- generator		Überroll- schutz		Batterie		Gas-tank		Hochvolt -leitung/ -komponente
	Gurt- straffer		Gasdruck- dämpfer		Kraftstoff- tank		Sicherheits- ventil		HV- Trennstelle

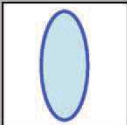
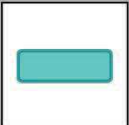

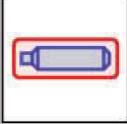
# VOLVO S80 BI-FUEL (TYP K, 1999-2006)

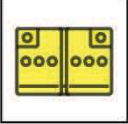

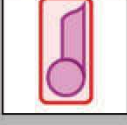
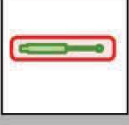
## Legende

	Airbag		Karosserieverstärkung		Steuergerät		mech. Sensor
	Gas-generator		Überrollschutz		Batterie		Gastank
	Gurtstraffer		Gasdruckdämpfer		Kraftstofftank		Sicherheitsventil



# VOLVO C30 ELECTRIC (TYP E, 2011-2013)

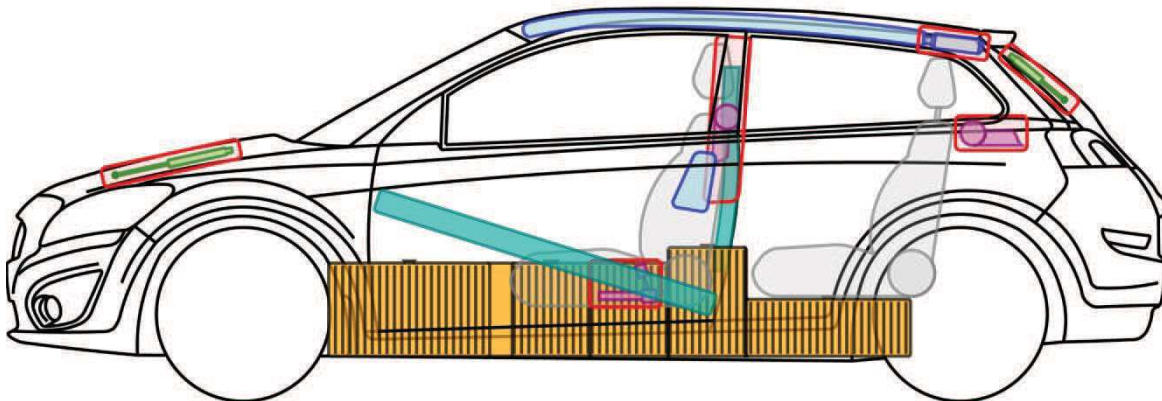
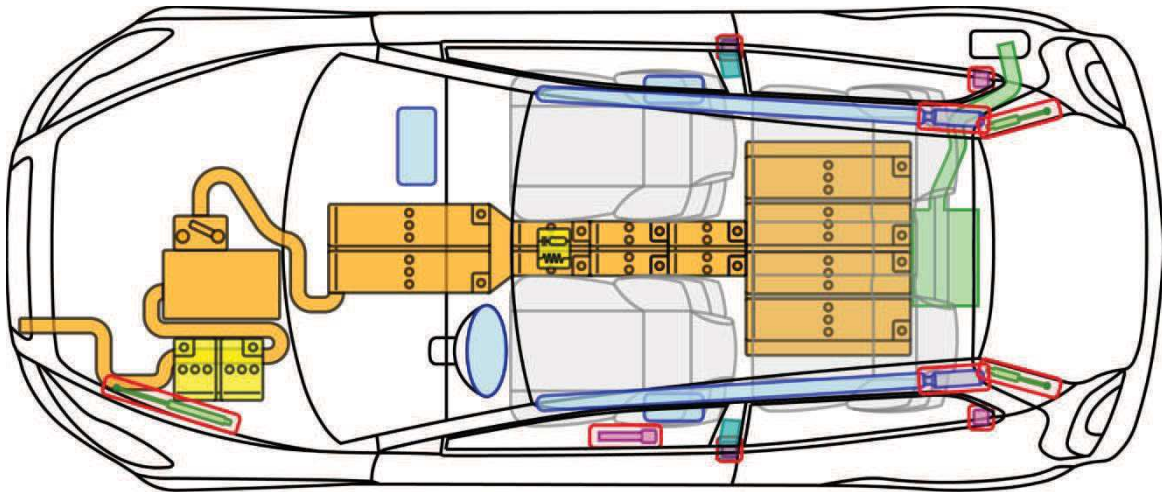

## Legende

	Airbag		Karosserie-verstärkung		Steuergerät		mech. Sensor		Hochvolt-batterie
	Gas-generator		Überroll-schutz		Batterie		Gas-tank		Hochvolt-leitung/-komponente
	Gurt-straffer		Gasdruck-dämpfer		Kraftstoff-tank		Sicherheits-ventil		HV-Trennstelle





# VOLVO XC60 T8 TWIN ENGINE (TYP U, 2017-)

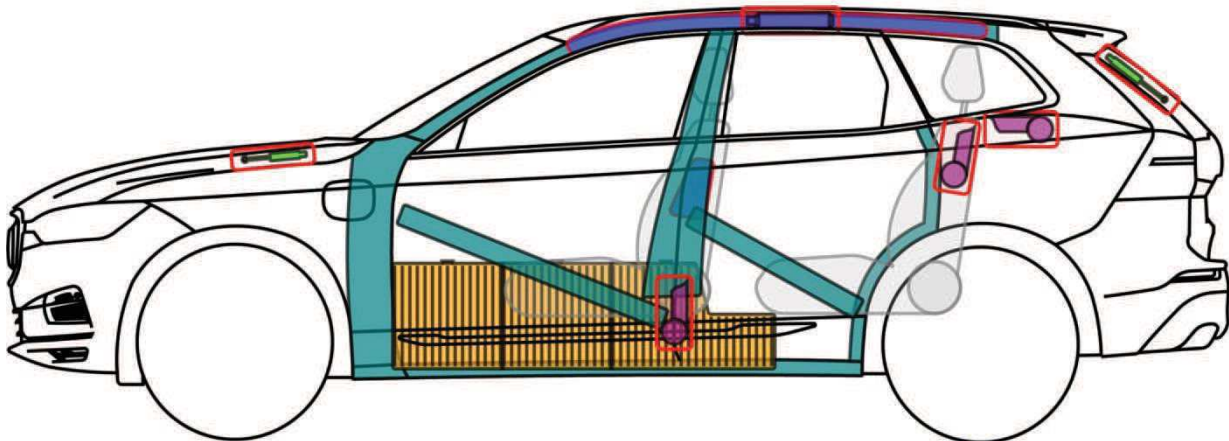
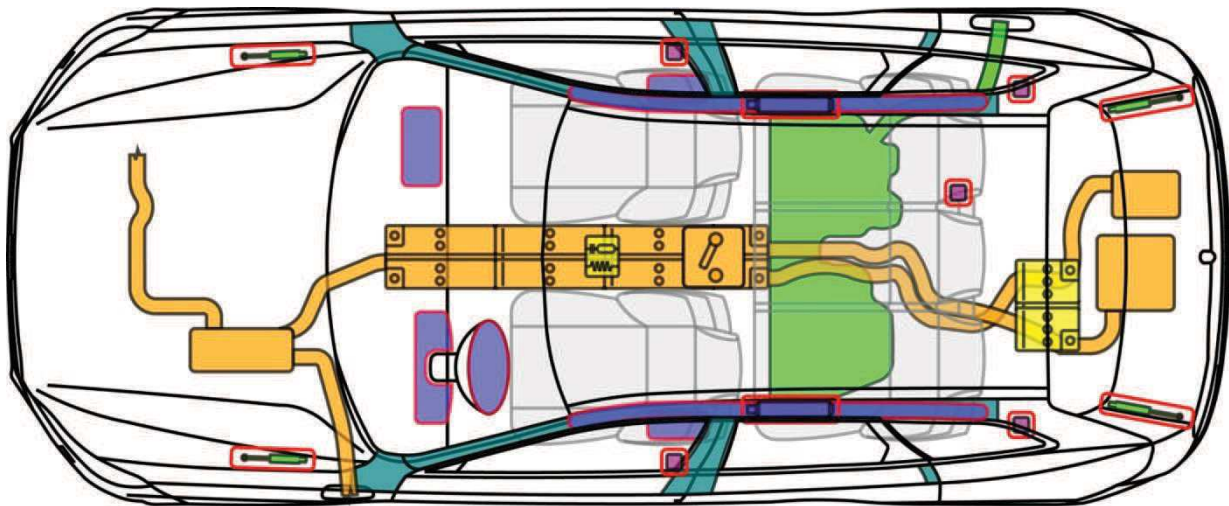

## Legende







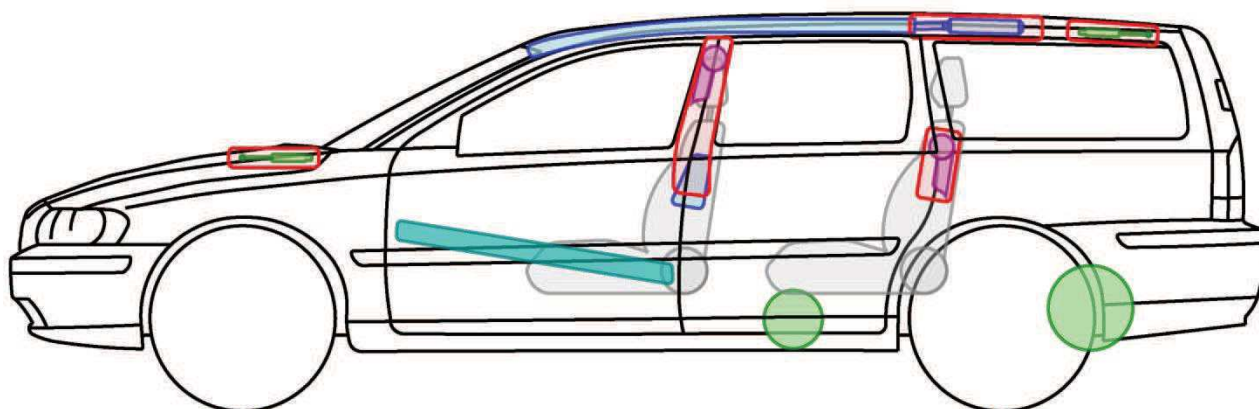
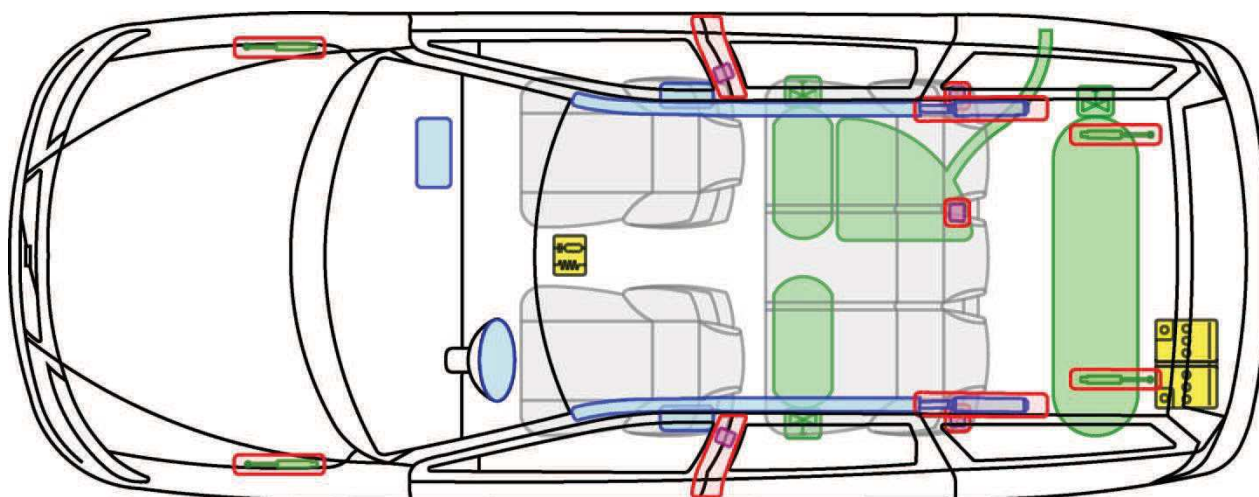

	Airbag		Karosserie- verstärkung		Steuergerät		Hochvolt- batterie
	Gas- generator		Überroll- schutz		Batterie		Hochvolt -leitung/ -komponente
	Gurt- straffer		Gasdruck- dämpfer		Kraftstoff- tank		HV- Trennstelle

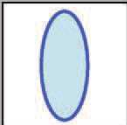
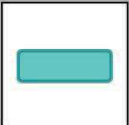

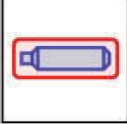
# VOLVO V70 BI-FUEL (TYP J, 2000-2007)

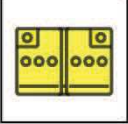

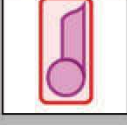
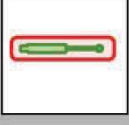
## Legende

	Airbag		Karosserie- verstärkung		Steuergerät		mech. Sensor
	Gas- generator		Überroll- schutz		Batterie		Gastank
	Gurt- straffer		Gasdruck- dämpfer		Kraftstoff- tank		Sicherheits- ventil



# VOLVO S90 T8 TWIN ENGINE (TYP P, 2017-)

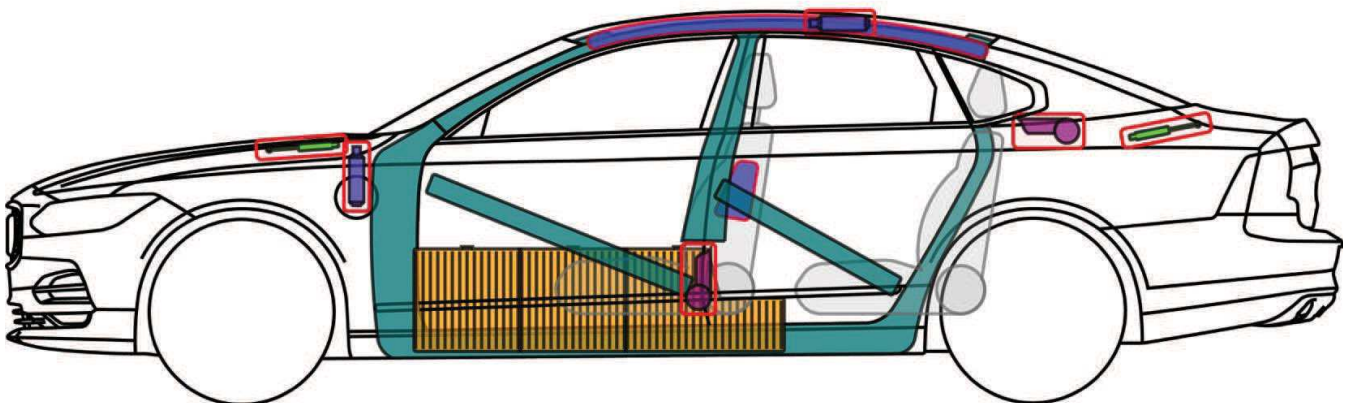
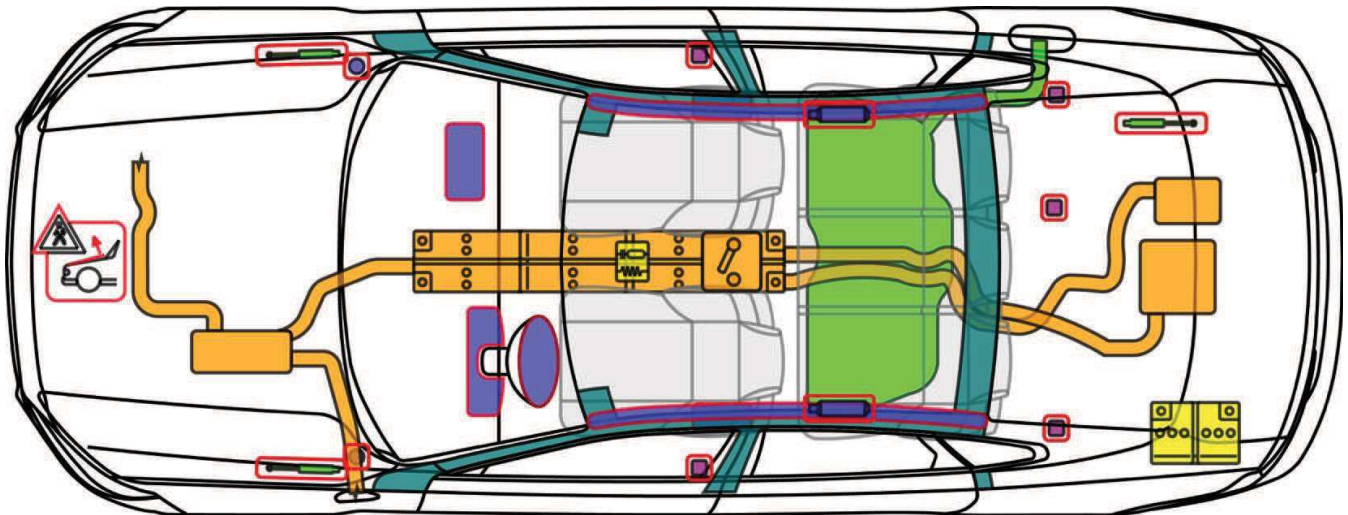

## Legende

	Airbag		Karosserie- verstärkung		Steuergerät		Hochvolt- batterie
	Gas- generator		Überroll- schutz		Batterie		Hochvolt -leitung/ -komponente
	Gurt- straffer		Gasdruck- dämpfer		Kraftstoff- tank		HV- Trennstelle



# VOLVO V60 PLUG-IN HYBRID (TYP F, 2012-)

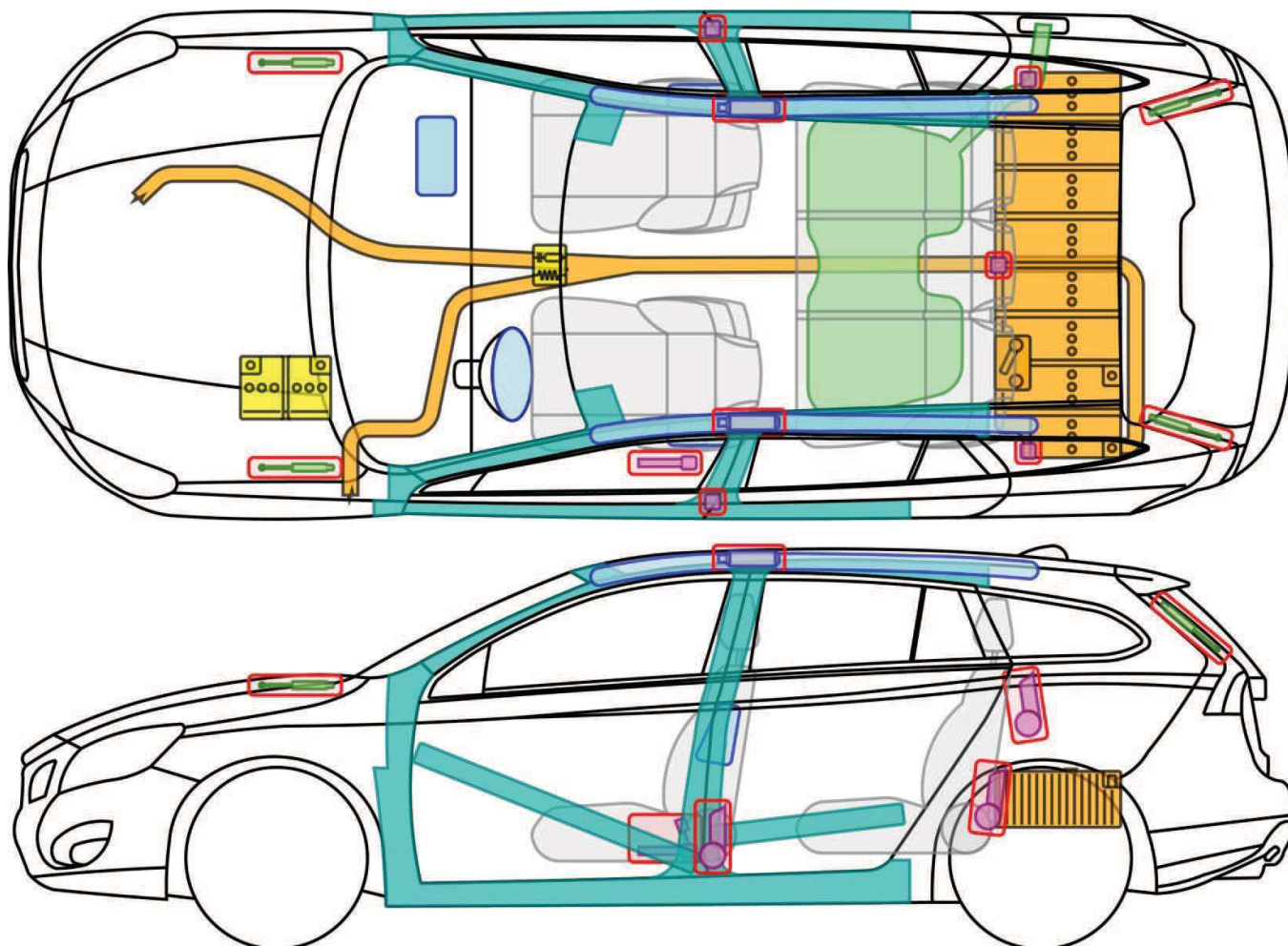

## Legende





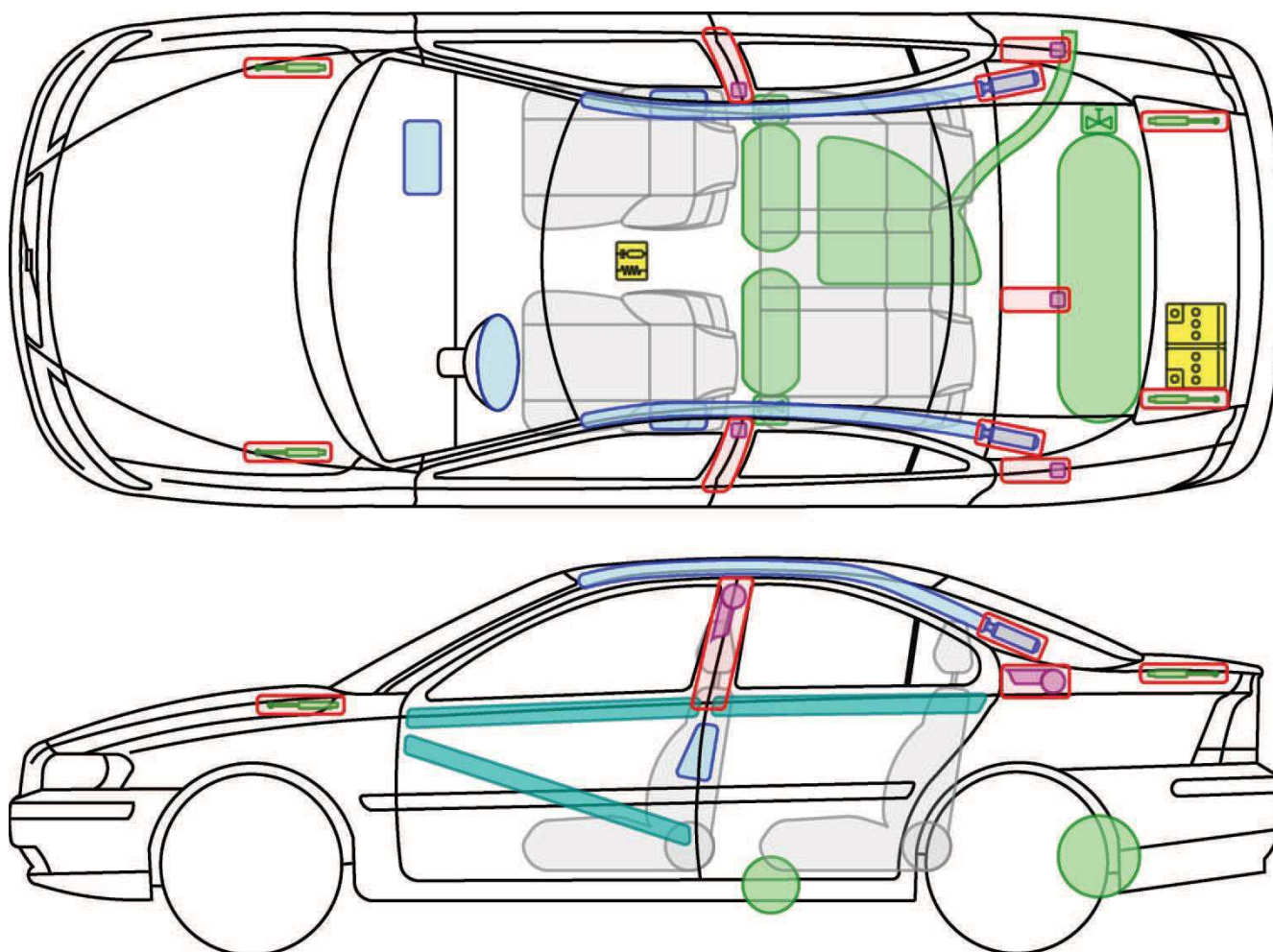

	Airbag		Karosserie-verstärkung		Steuergerät		mech. Sensor		Hochvolt-batterie
	Gas-generator		Überroll-schutz		Batterie		Gastank		Hochvolt-leitung/-komponente
	Gurt-straffer		Gasdruck-dämpfer		Kraftstoff-tank		Sicherheits-ventil		HV-Trennstelle

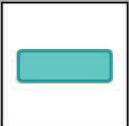

# VOLVO S60 BI-FUEL (TYP H, 2001-2007)

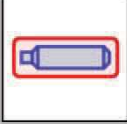

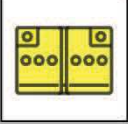
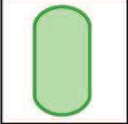
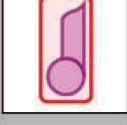
## Legende







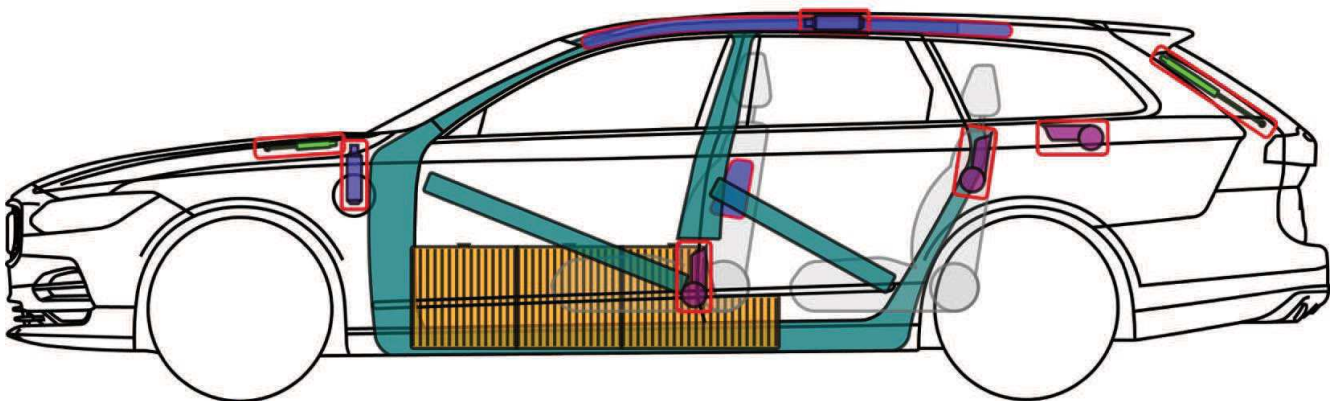
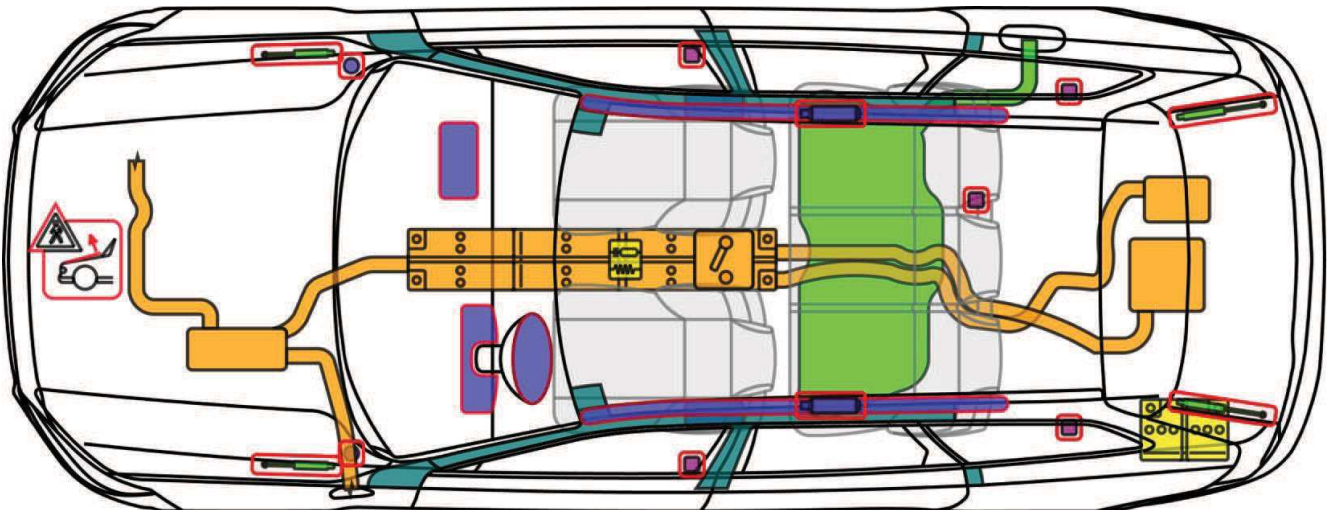

	Airbag		Karosserie- verstärkung		Steuergerät		mech. Sensor
	Gas- generator		Überroll- schutz		Batterie		Gastank
	Gurt- straffer		Gasdruck- dämpfer		Kraftstoff- tank		Sicherheits- ventil

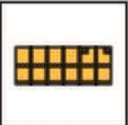

# VOLVO V90 T8 TWIN ENGINE (TYP P, 2017-)

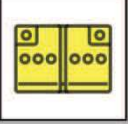

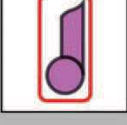
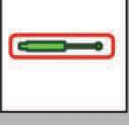
## Legende

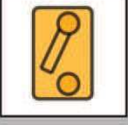
	Airbag		Karosserie- verstärkung		Steuergerät		Hochvolt- batterie
	Gas- generator		Überroll- schutz		Batterie		Hochvolt -leitung/ -komponente
	Gurt- straffer		Gasdruck- dämpfer		Kraftstoff- tank		HV- Trennstelle