

Karty ratunkowe do pojazdów Mazda

Karty ratunkowe przeznaczone do ratowania osób

W razie wypadku, szybkie i właściwe działanie jest najważniejszym warunkiem udzielenia skutecznej pomocy kierowcy i pasażerom. Karty ratunkowe do pojazdów Mazda dostarczają służbom ratowniczym ważne informacje dla ich efektywnego działania. Wskazują one miejsca montażu głównych komponentów pojazdu, co pozwala na szybki i bezpieczny dostęp do kierowcy i pasażerów. Karty ratunkowe Mazda są udostępniane w formie plików PDF. Zalecamy ich wydrukowanie w kolorze i przechowywanie w pojeździe za osłoną przeciwsłoneczną kierowcy.

Uwaga:







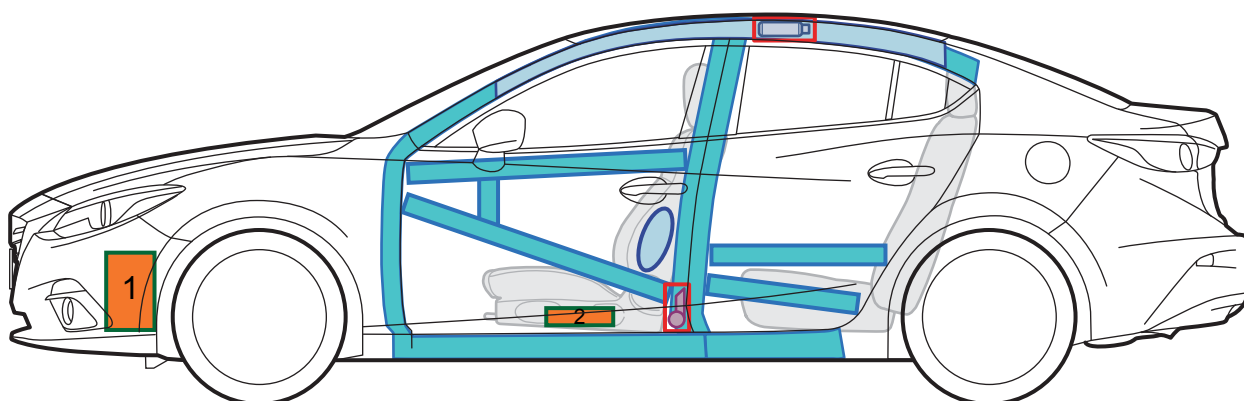
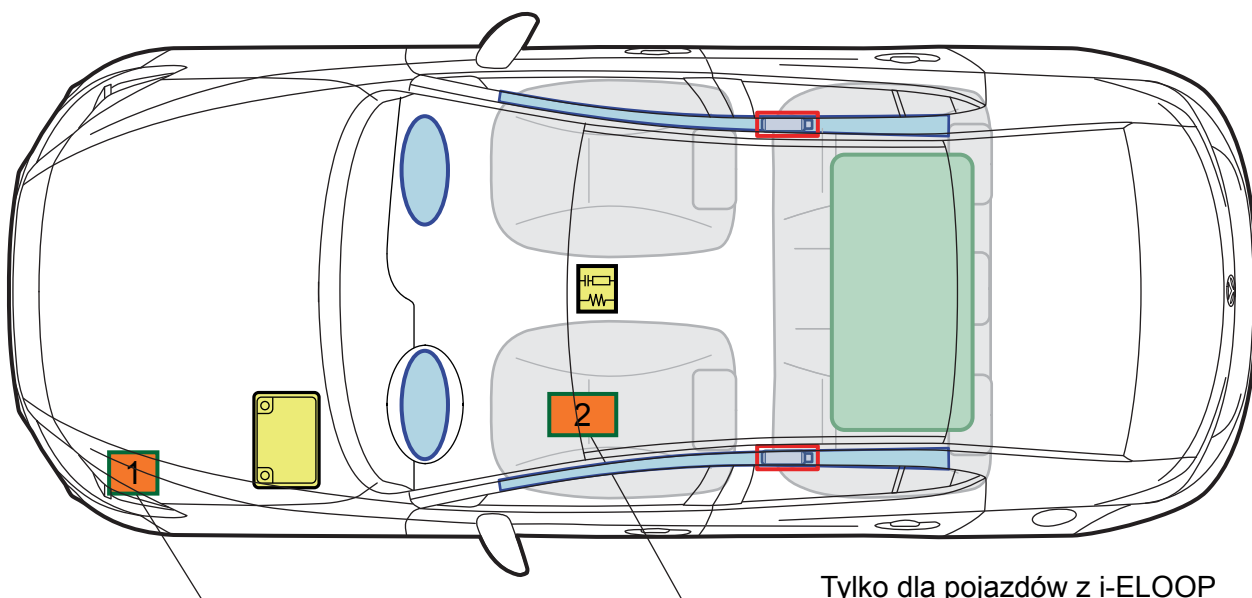



Informacje zawarte w kartach ratunkowych nie są przeznaczone dla użytkowników pojazdów oraz serwisów czy salonów samochodowych. Użytkownicy pojazdów mogą uzyskać szczegółowe informacje o działaniu pojazdu, jak również ważne wskazówki dotyczące bezpieczeństwa kierowcy i pasażerów w instrukcji obsługi danego pojazdu Mazda. Serwisy i salony samochodowe informacje dotyczące napraw pojazdu uzyskują z dokumentacji technicznej pochodzącej z innych źródeł.



MAZDA3 BN SEDAN



Tylko dla pojazdów z i-ELOOP

	Poduszka powietrzna		Wzmocnienie nadwozia		Moduł sterujący poduszek powietrznych
	Generator gazu		Sprężyna gazowa		Akumulator
	Napinacz pasa bezpieczeństwa		Zbiornik paliwa		Kondensator elektrolityczny
					Przetwornica DC-DC





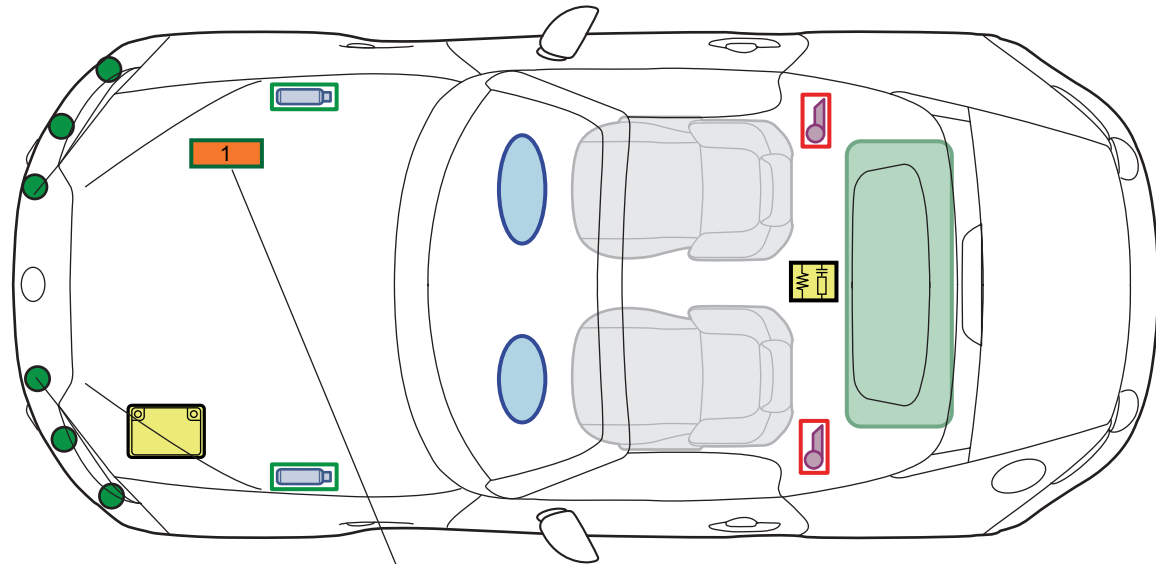



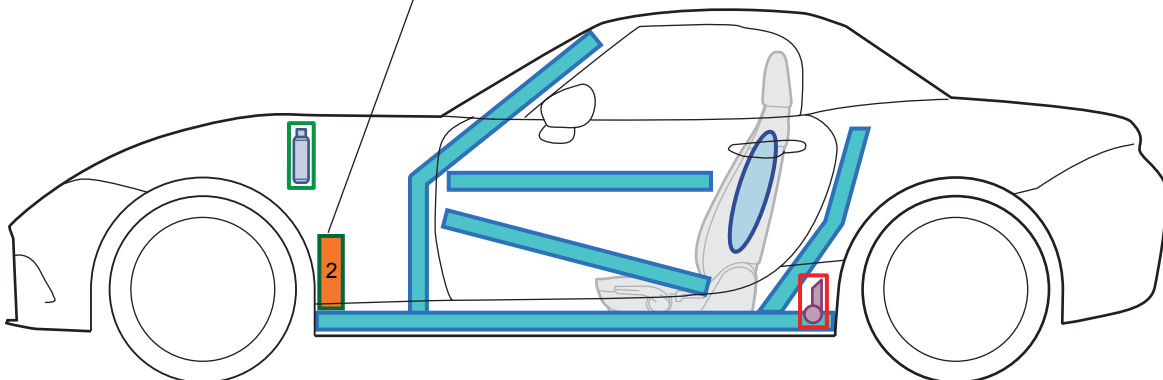



MAZDA MX-5 ND RF

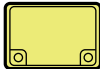

Tylko dla pojazdów z i-ELOOP



	Poduszka powietrzna		Wzmocnienie nadwozia		Moduł sterujący poduszek powietrznych
	Generator gazu		Czujnik		Akumulator
	Aktywna pokrywa silnika		Aktywna pokrywa silnika		1 Przetwornica DC-DC
	Napinacz pasa bezpieczeństwa		Zbiornik paliwa		2 Kondensator elektrolityczny





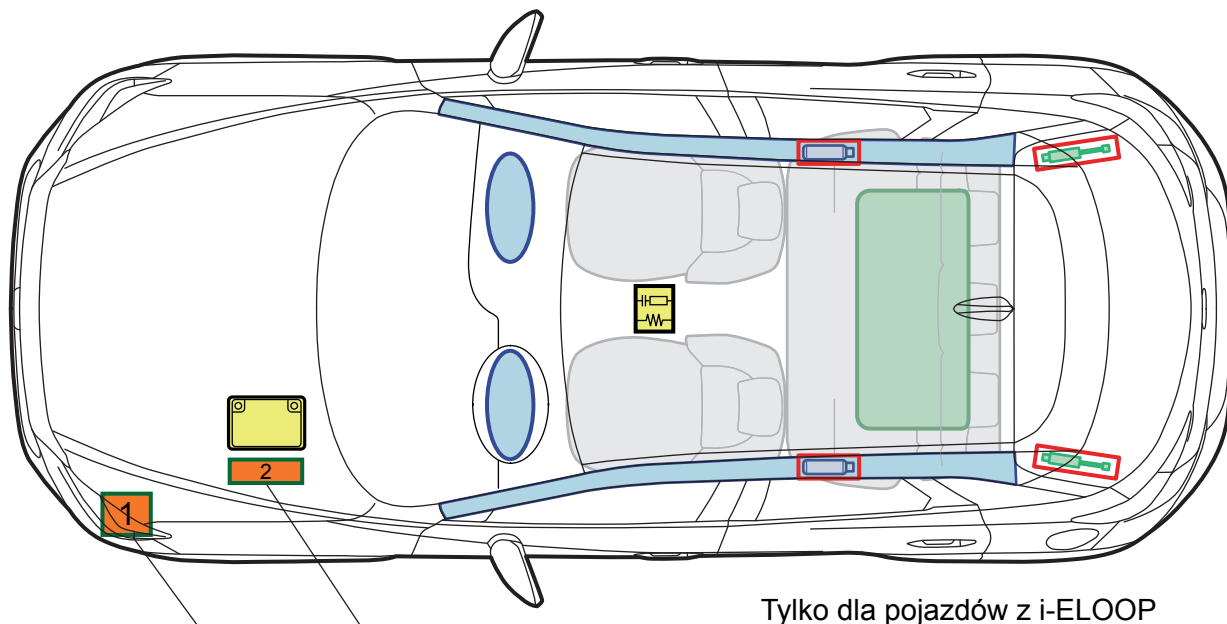



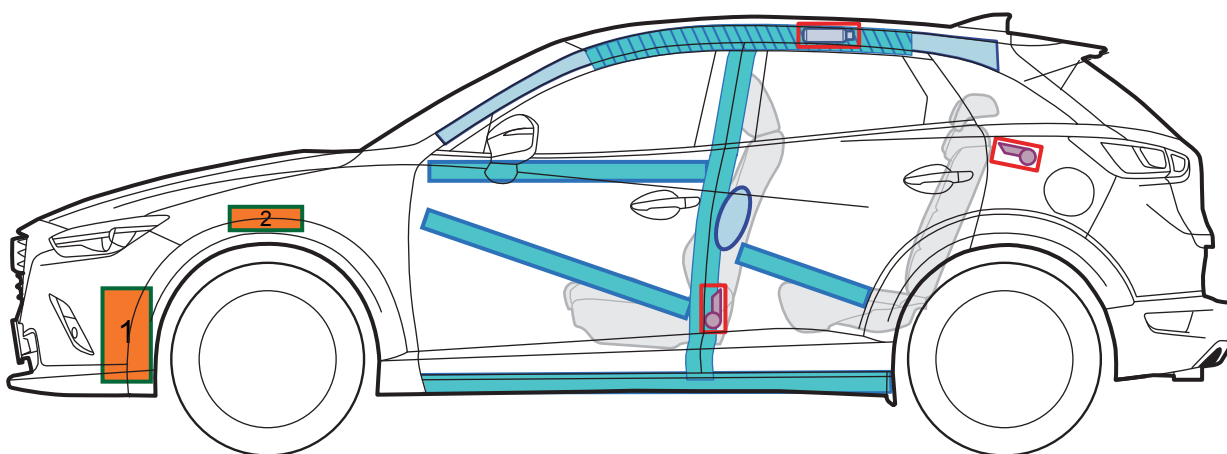

MAZDA CX-3 DK

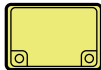

Tylko dla pojazdów z i-ELOOP









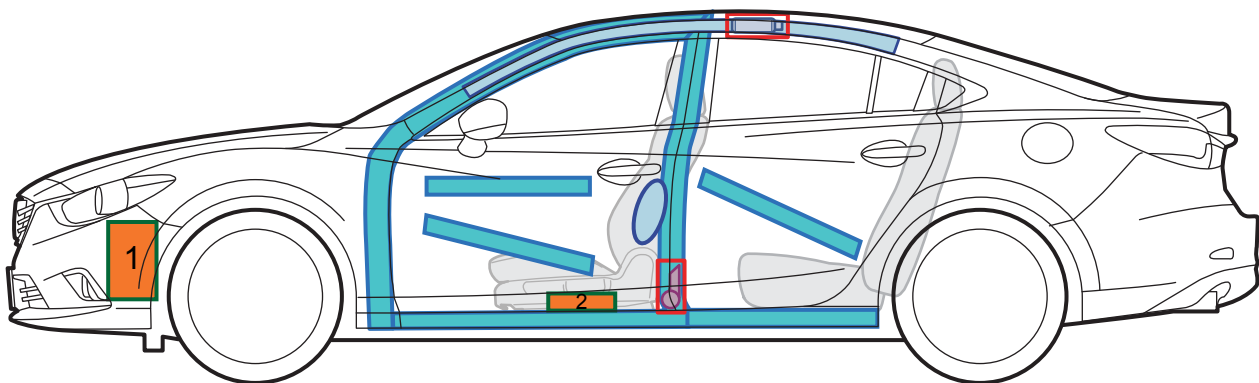
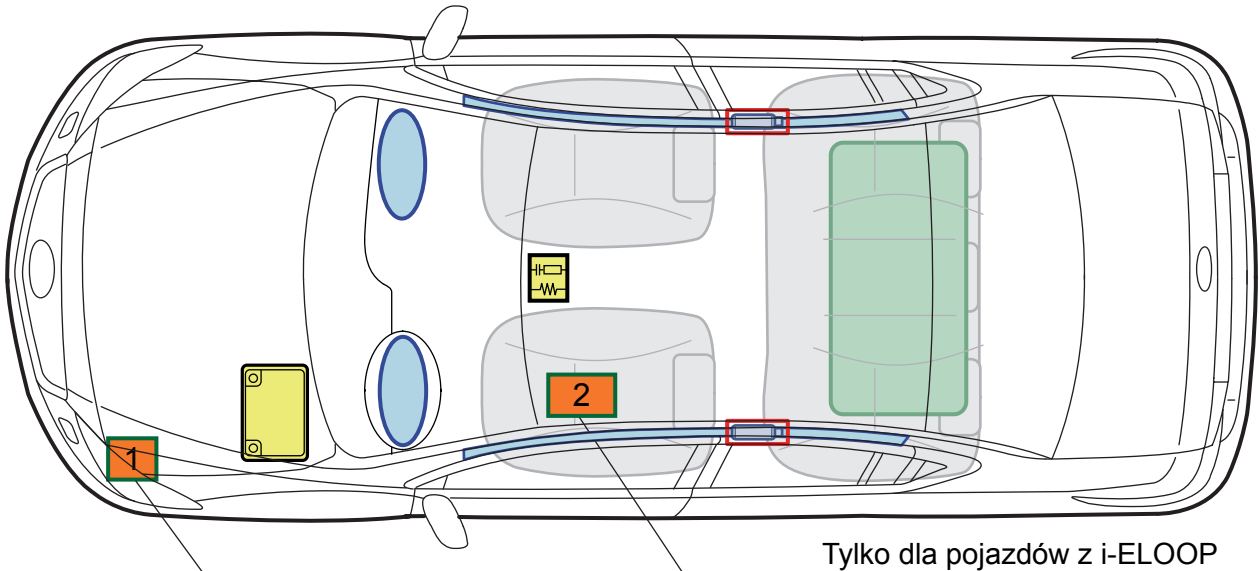

	Poduszka powietrzna		Wzmocnienie nadwozia		Moduł sterujący poduszek powietrznych
	Generator gazu		Sprężyna gazowa		Akumulator
	Napinacz pasa bezpieczeństwa		Zbiornik paliwa		Kondensator elektrolityczny
					Przetwornica DC-DC

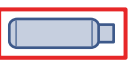

MAZDA6 GL SEDAN



	Poduszka powietrzna		Wzmocnienie nadwozia		Moduł sterujący poduszek powietrznych
	Generator gazu		Sprężyna gazowa		Akumulator
	Napinacz pasa bezpieczeństwa		Zbiornik paliwa		1 Kondensator elektrolityczny
					2 Przetwornica DC-DC









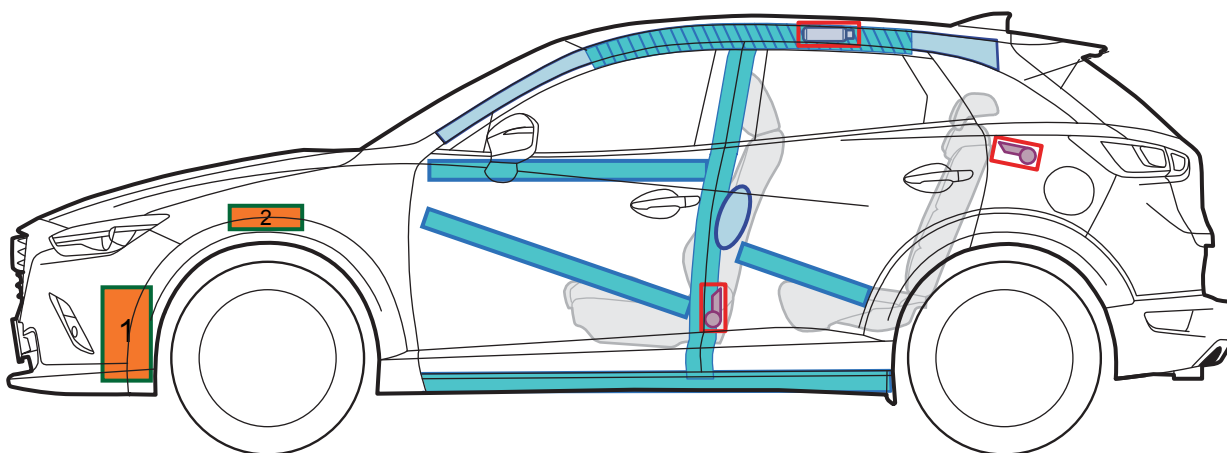
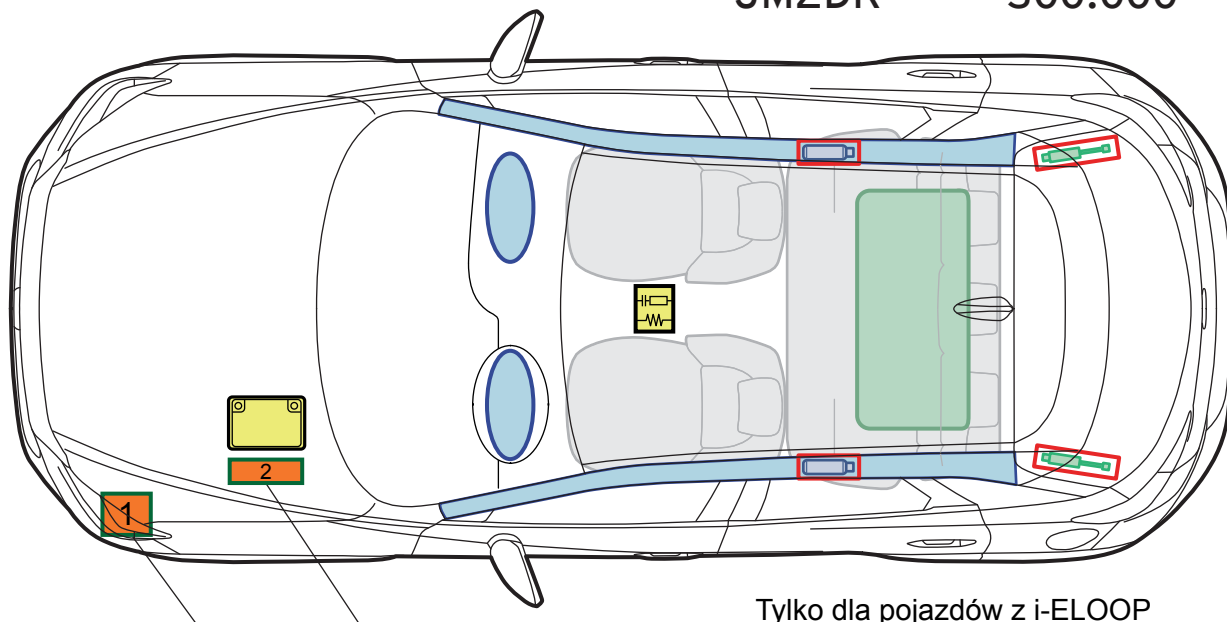

ZOOM-ZOOM

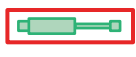

MAZDA CX-3 DK 2017

JMZDK*****300.000



	Poduszka powietrzna		Wzmocnienie nadwozia		Moduł sterujący poduszek powietrznych
	Generator gazu		Sprężyna gazowa		Akumulator
	Napinacz pasa bezpieczeństwa		Zbiornik paliwa		1 Kondensator elektrolityczny
					2 Przetwornica DC-DC







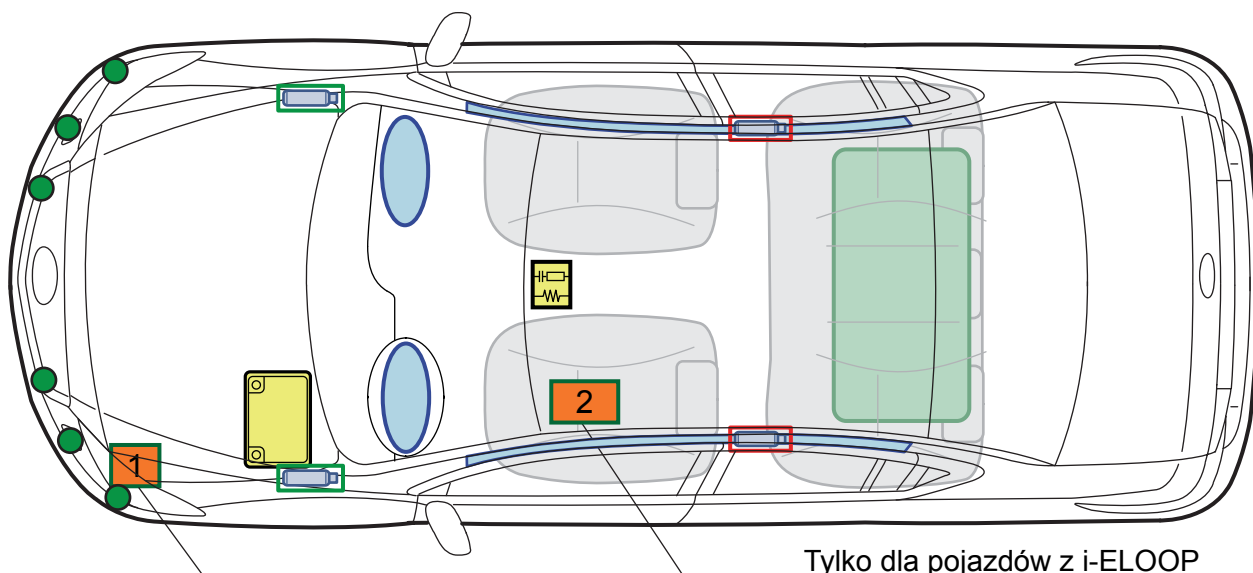



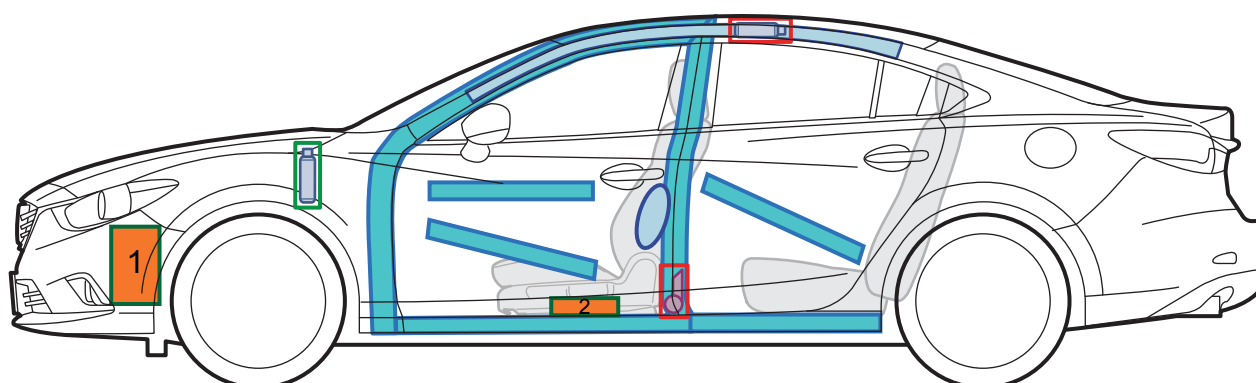



MAZDA6 GL 2018 SEDAN

JMZGL*****600 001-

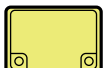

Tylko dla pojazdów z i-ELOOP



	Poduszka powietrzna		Wzmocnienie nadwozia		Moduł sterujący poduszek powietrznych
	Generator gazu		Sprężyna gazowa		Akumulator
<u>Aktywna pokrywa silnika</u>		<u>Aktywna pokrywa silnika</u>			Zbiornik paliwa
	Generator gazu		Czujnik generatora gazu	<u>i-ELOOP</u>	
	Napinacz pasa bezpieczeństwa		<u>i-ELOOP</u> Kondensator elektrolityczny		Przetwornica DC-DC



MAZDA CX-5 KF

JMZKF*****100.000



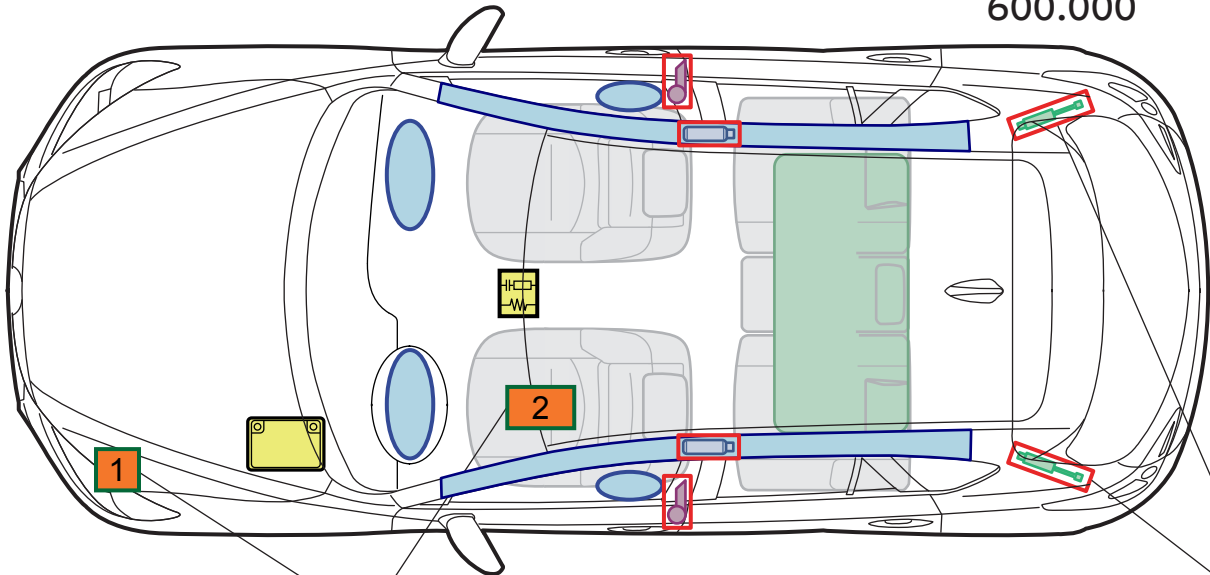



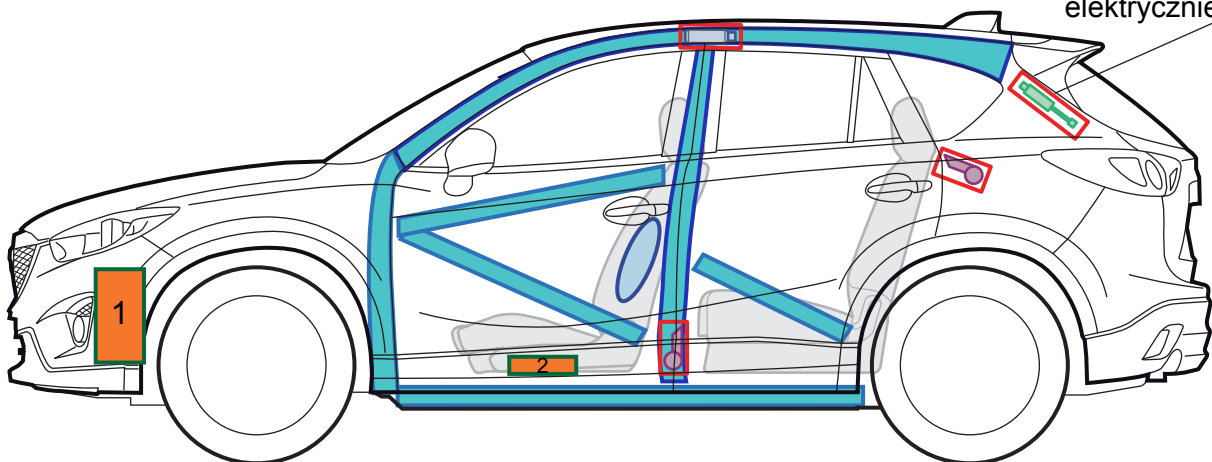

600.000

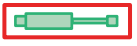
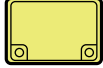

Tylko dla pojazdów z i-ELOOP

Tylko dla pojazdów bez drzwi tyłu nadwozia otwierane elektrycznie









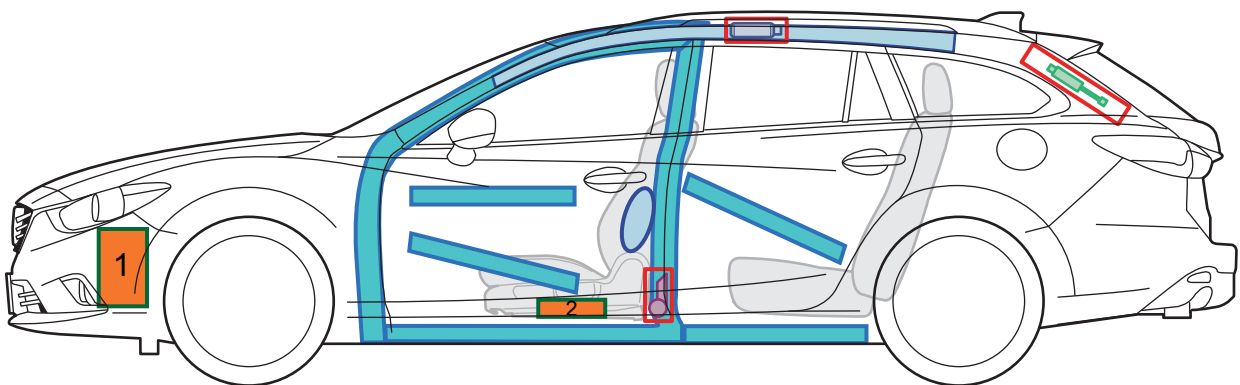
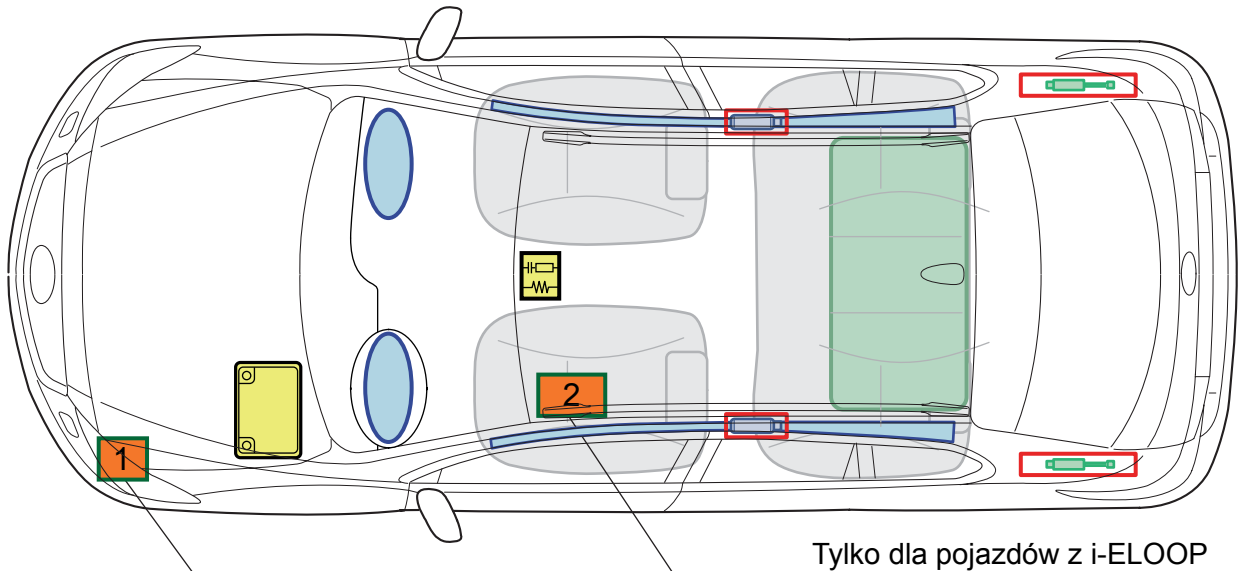

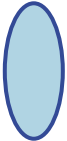
	Poduszka powietrzna		Wzmocnienie nadwozia		Moduł sterujący poduszek powietrznych
	Generator gazu		Sprężyna gazowa		Akumulator
	Napinacz pasa bezpieczeństwa		Zbiornik paliwa		Kondensator elektrolityczny
					Przetwornica DC-DC

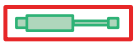
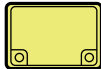

MAZDA6 GJ KOMBI



	Poduszka powietrzna		Wzmocnienie nadwozia		Moduł sterujący poduszek powietrznych
	Generator gazu		Sprężyna gazowa		Akumulator
	Napinacz pasa bezpieczeństwa		Zbiornik paliwa		1 Kondensator elektrolityczny 2 Przetwornica DC-DC





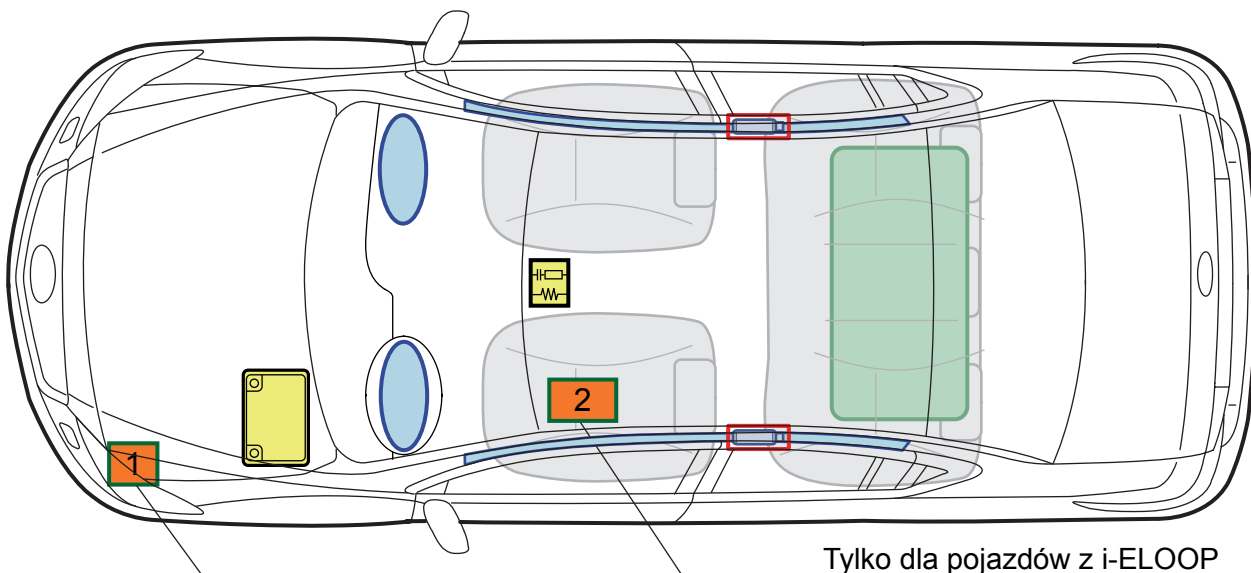



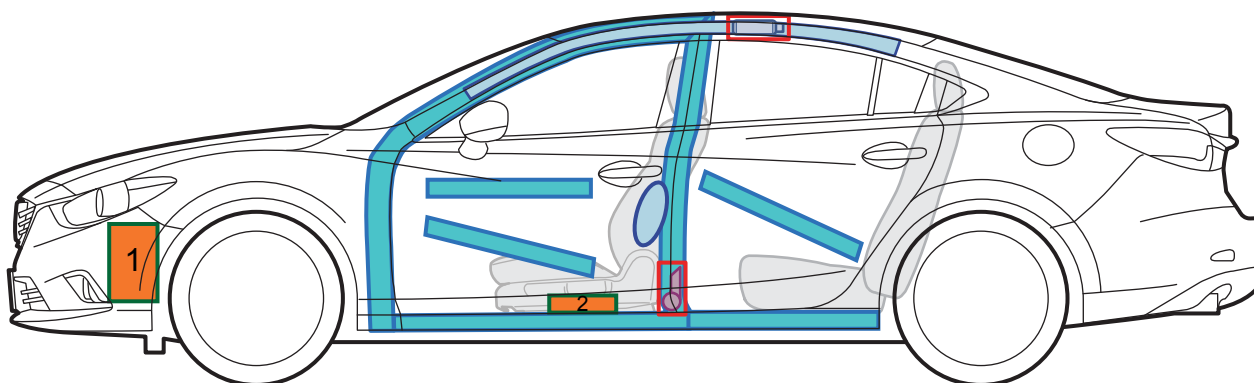

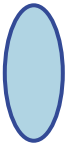
MAZDA6 GJ SEDAN

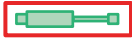
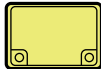

Tylko dla pojazdów z i-ELOOP









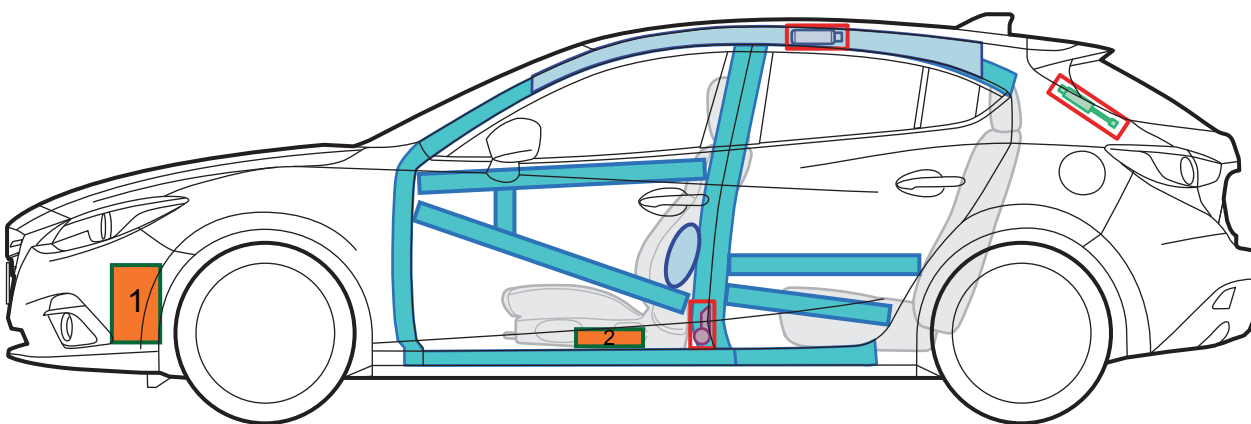
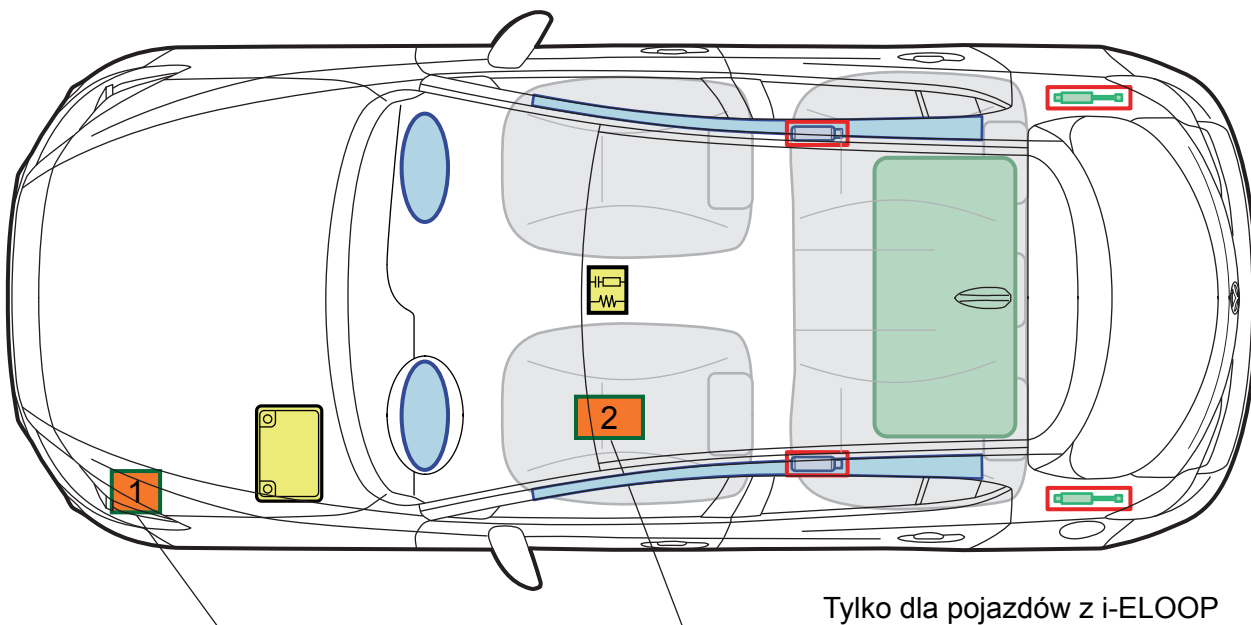



	Poduszka powietrzna		Wzmocnienie nadwozia		Moduł sterujący poduszek powietrznych
	Generator gazu		Sprężyna gazowa		Akumulator
	Napinacz pasa bezpieczeństwa		Zbiornik paliwa		Kondensator elektrolityczny
					Przetwornica DC-DC



MAZDA3 BN HATCHBACK



	Poduszka powietrzna		Wzmocnienie nadwozia		Moduł sterujący poduszek powietrznych
	Generator gazu		Sprężyna gazowa		Akumulator
	Napinacz pasa bezpieczeństwa		Zbiornik paliwa		Kondensator elektrolityczny
					Przetwornica DC-DC