

RC300h

LHD









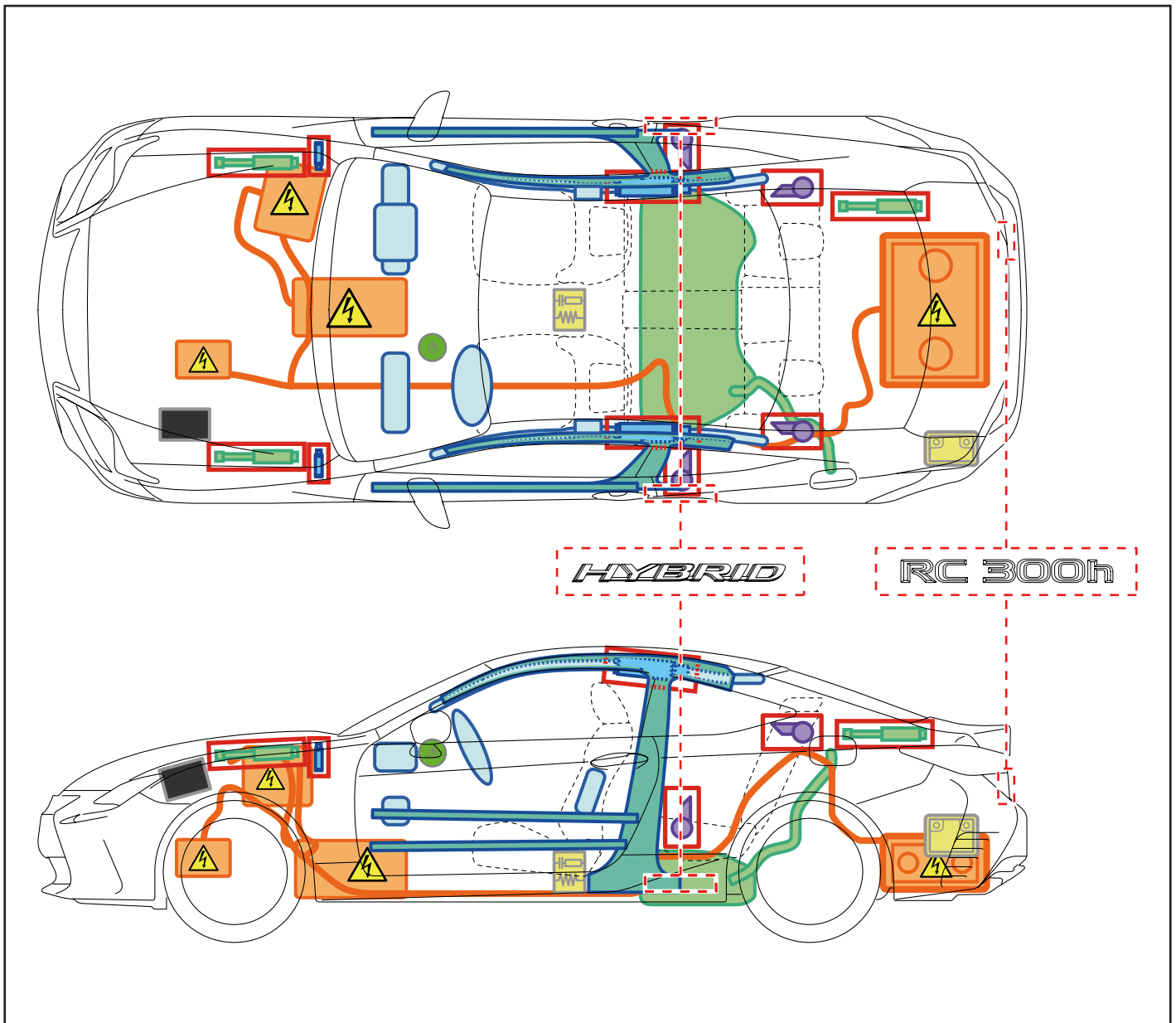



2015-10



LEXUS

LEXUS
HYBRID
DRIVE



	Wyłącznik zapłonu/ Przycisk rozruchu		Skrzynka bezpieczników		Akumulator 12V
	Poduszka powietrzna (w tym napełniacz)		Generator gazu		Akumulator wysokonapięciowy
	Obwód wysokiego napięcia		Zbiornik paliwa		Sprężyna gazowa
	Napinacz pasa bezpieczeństwa		Wzmocnienie nadwozia		Sterownik
-	-	-	-	-	-

Zabezpieczenie pojazdu

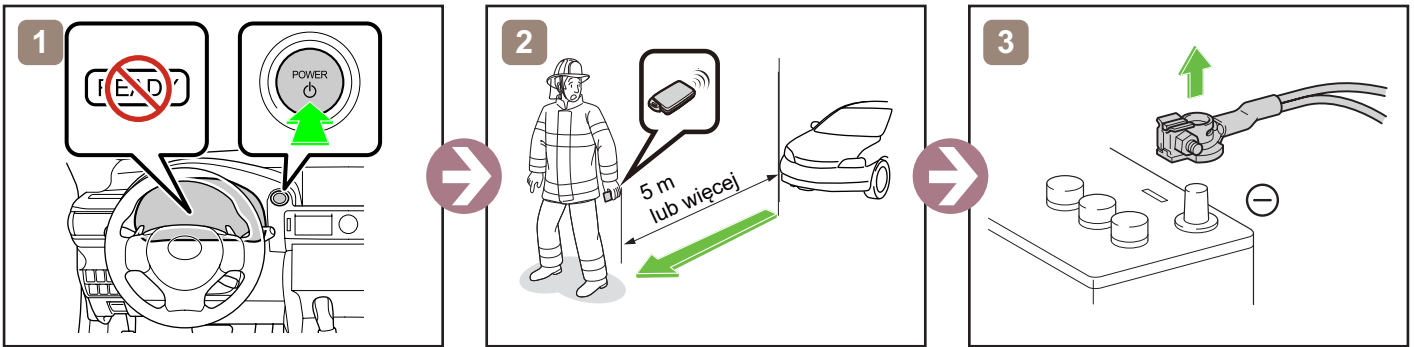

lub

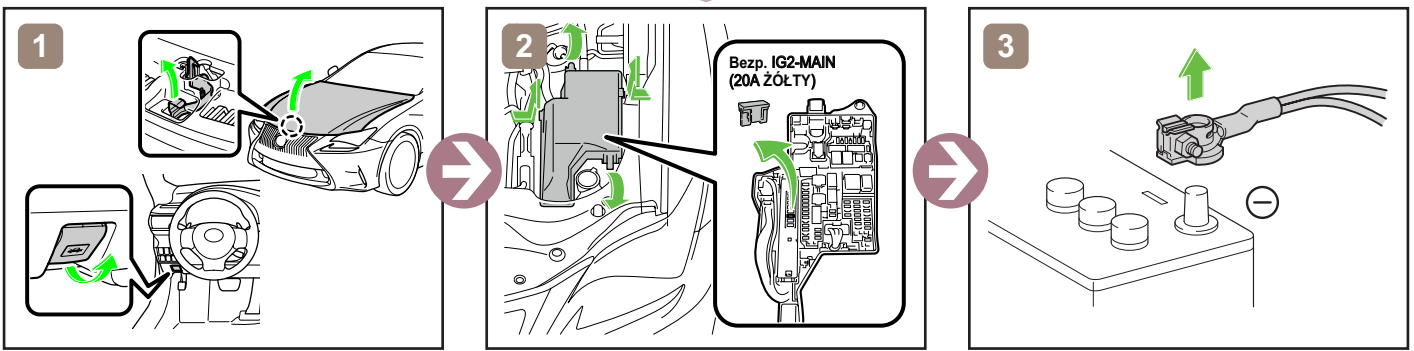

Dostęp do akumulatora 12V

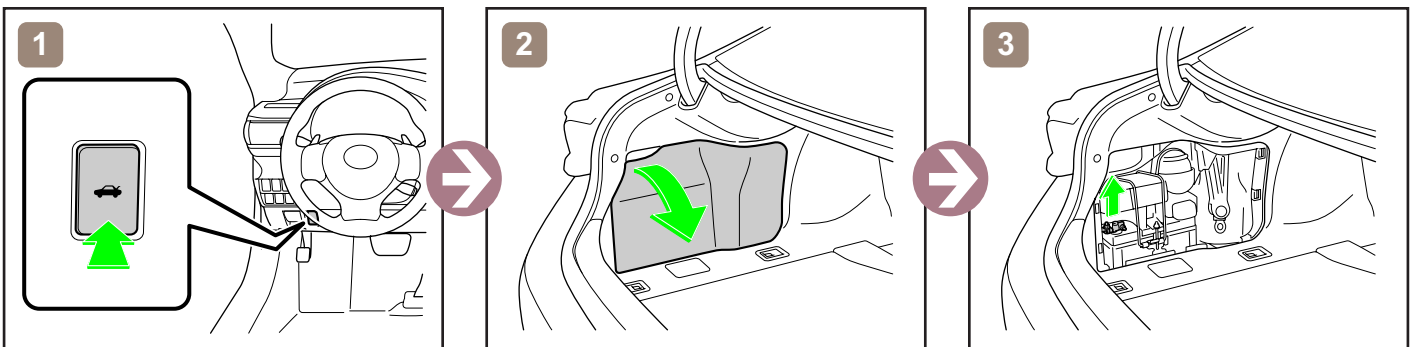

Holowanie pojazdu

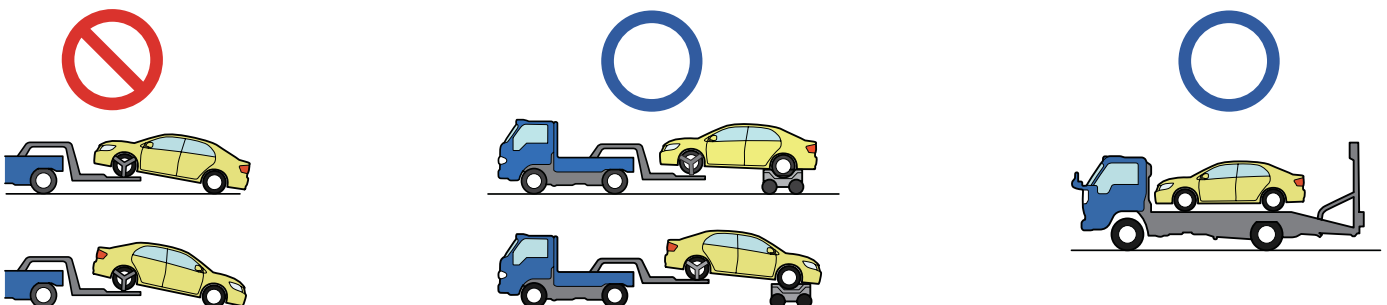

RX450h

LHD



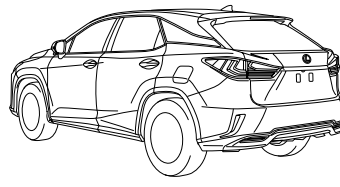
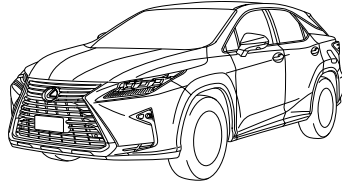





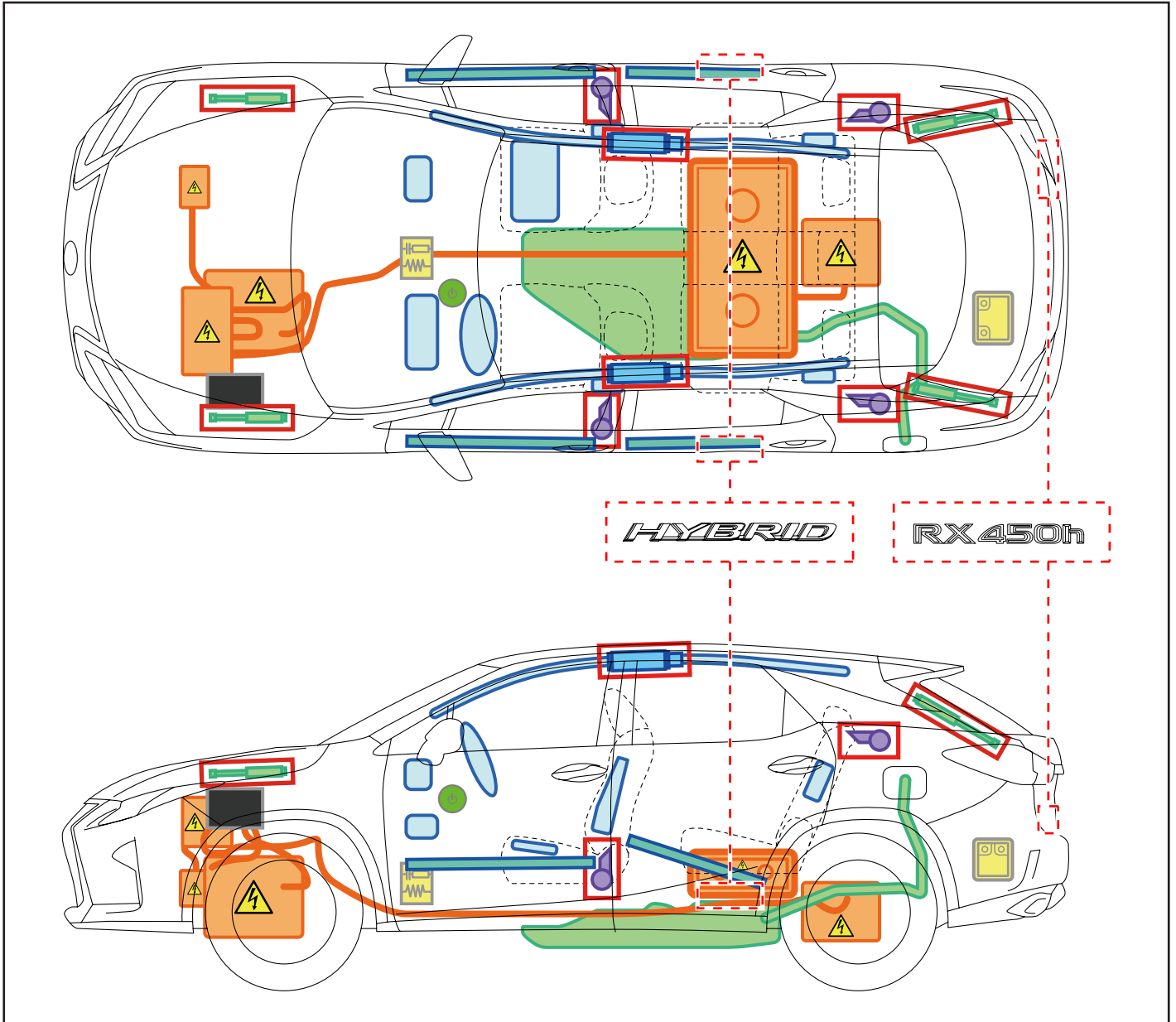



2015-10



LEXUS

LEXUS
HYBRID
DRIVE



	Wyłącznik zapłonu/ Przycisk rozruchu		Skrzynka bezpieczników		Akumulator 12V
	Poduszka powietrzna (w tym napełniacz)		Generator gazu		Akumulator wysokonapięciowy
	Obwód wysokiego napięcia		Zbiornik paliwa		Sprężyna gazowa
	Napinacz pasa bezpieczeństwa		Wzmocnienie nadwozia		Sterownik
-	-	-	-	-	-

Zabezpieczenie pojazdu

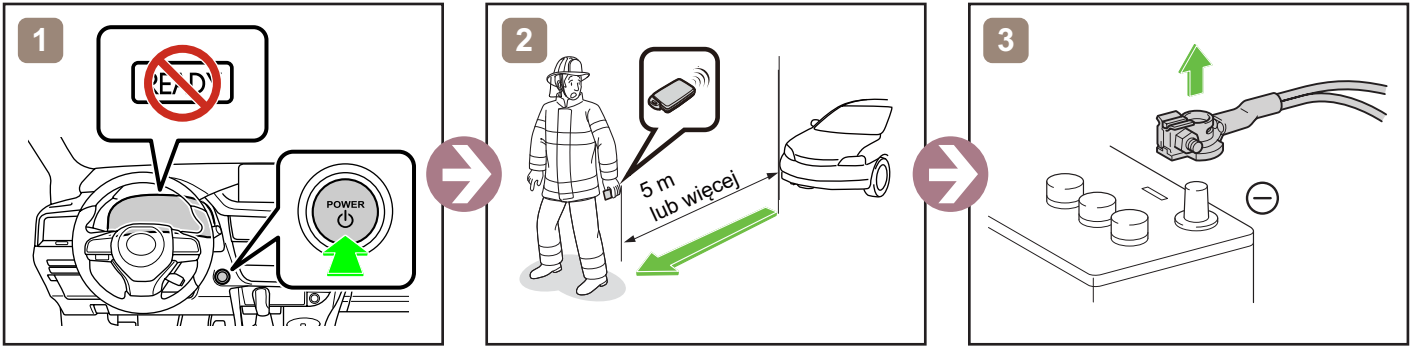

lub

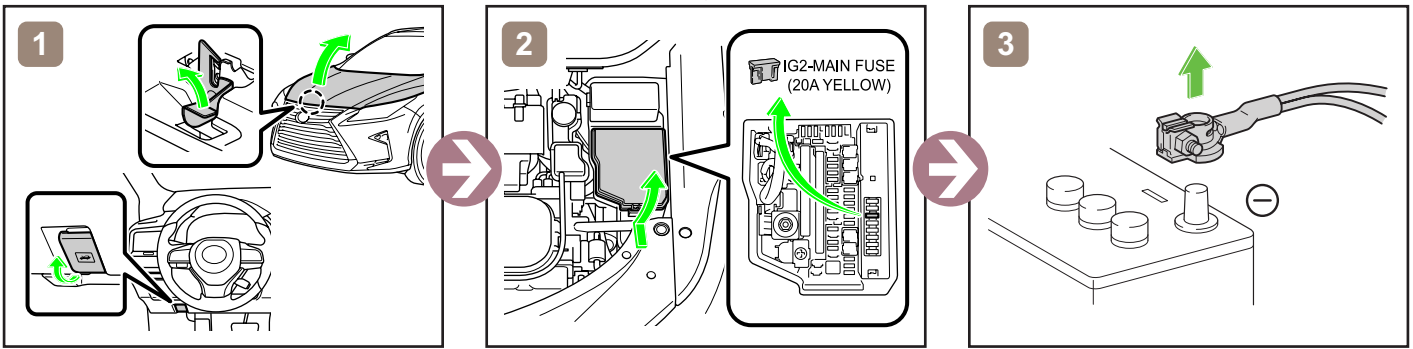

Dostęp do akumulatora 12V

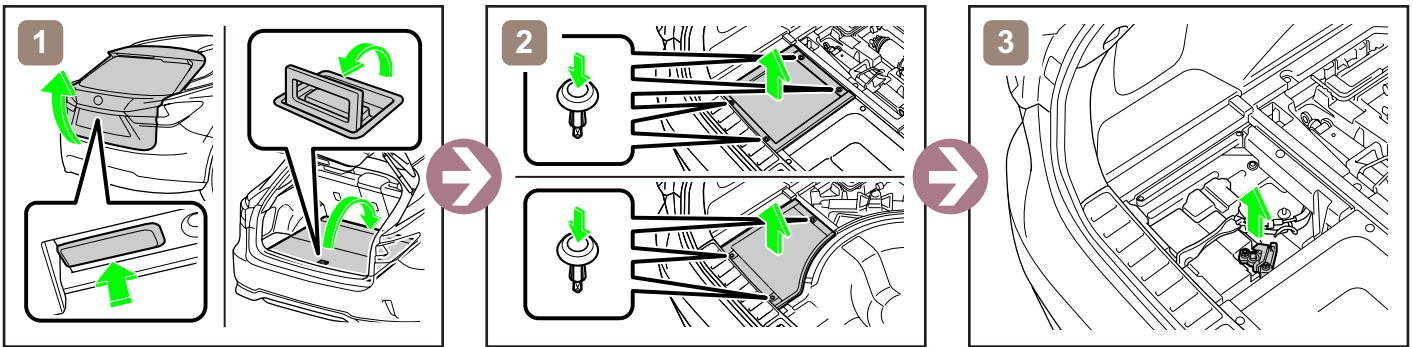

Holowanie pojazdu

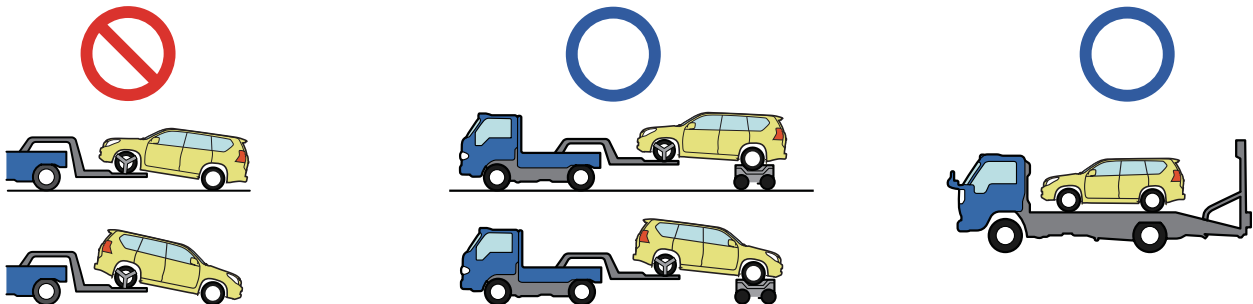

UX250h /260h

LHD

2018-10

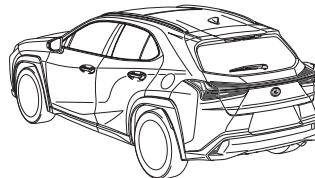
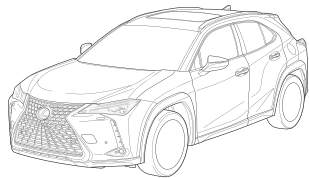

LEXUS



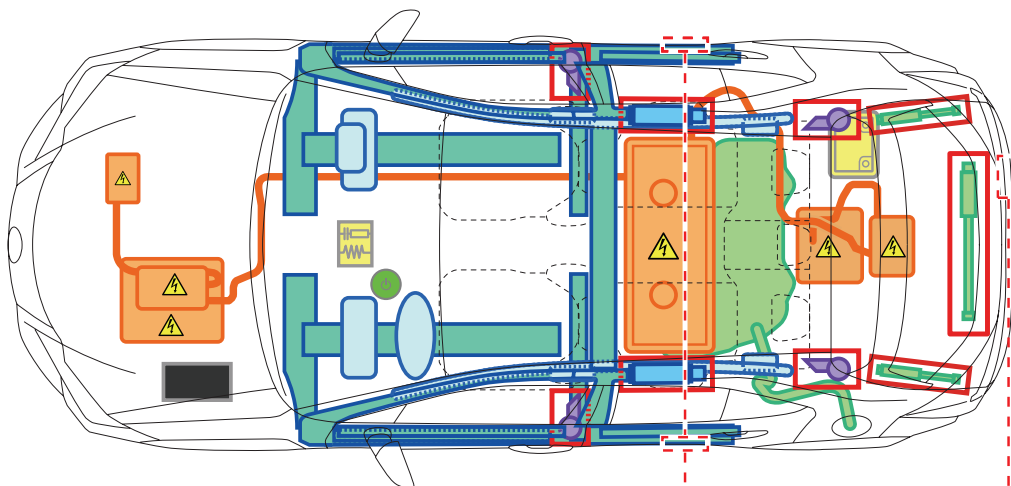





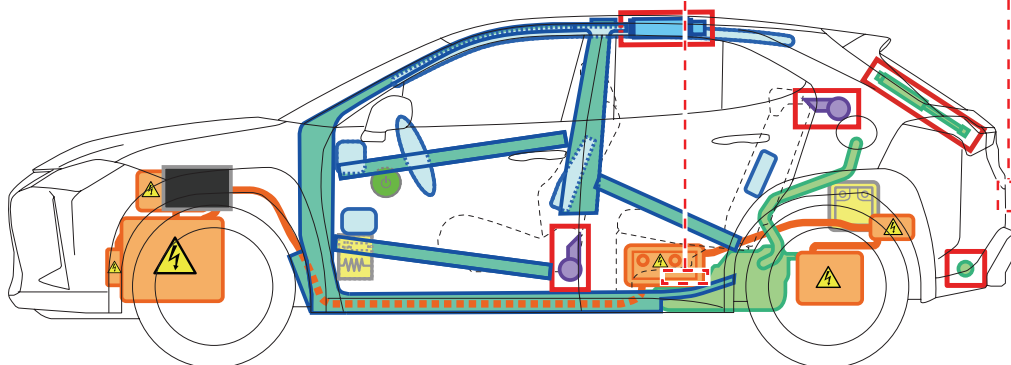



LEXUS
HYBRID
DRIVE



HYBRID

UX 250h
UX 260h



	Wyłącznik zapłonu/ Przycisk rozruchu		Skrzynka bezpieczników		Akumulator 12V
	Poduszka powietrzna (w tym napełniacz)		Generator gazu		Akumulator wysokonapięciowy
	Obwód wysokiego napięcia		Zbiornik paliwa		Sprężyna gazowa
	Napinacz pasa bezpieczeństwa		Wzmocnienie nadwozia		Sterownik
-	-	-	-	-	-

Zabezpieczenie pojazdu

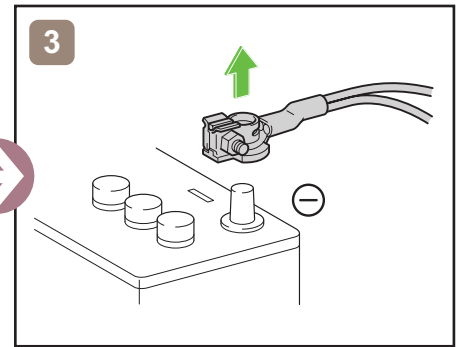
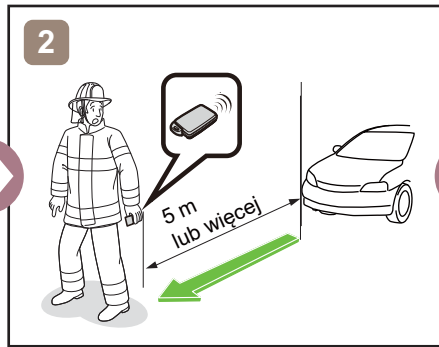
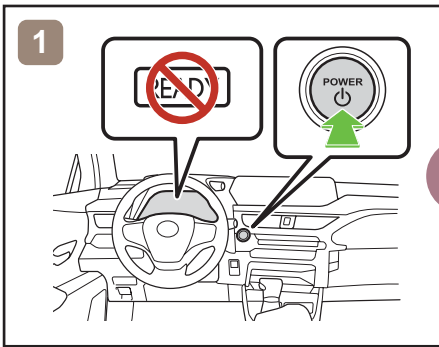

lub

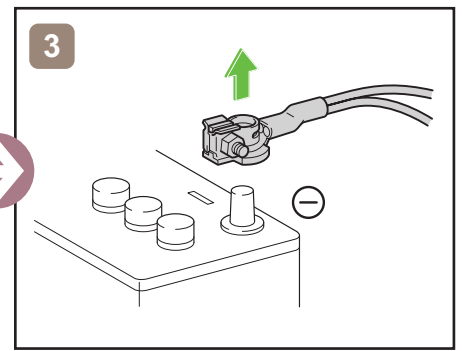
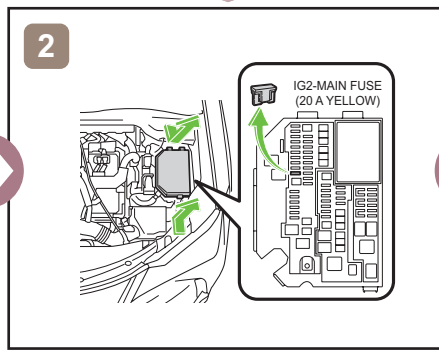
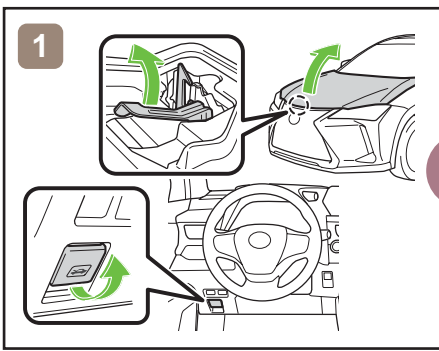

Dostęp do akumulatora 12V

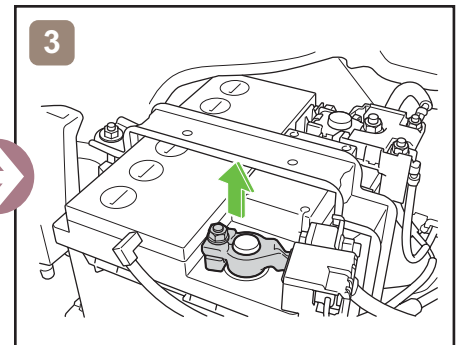
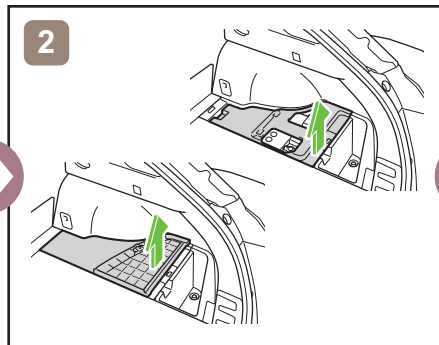
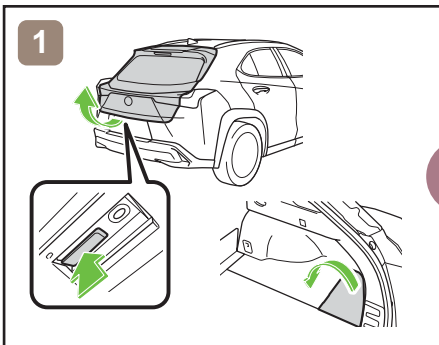

Holowanie pojazdu

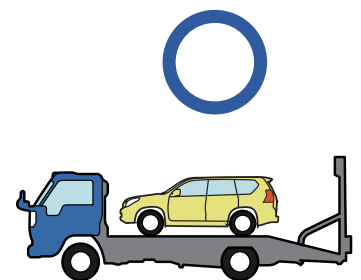
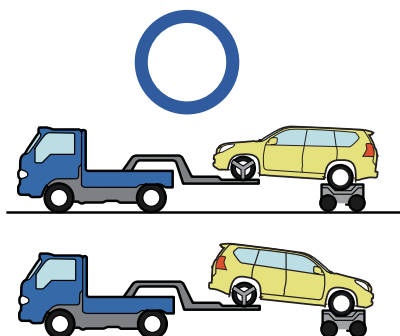
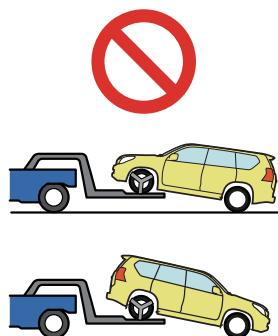

CT200h

LHD



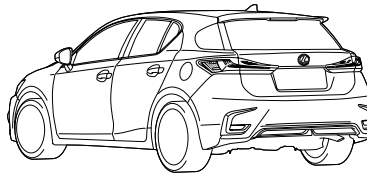
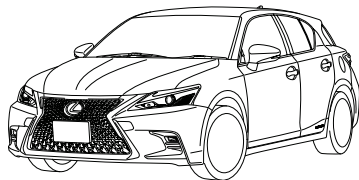





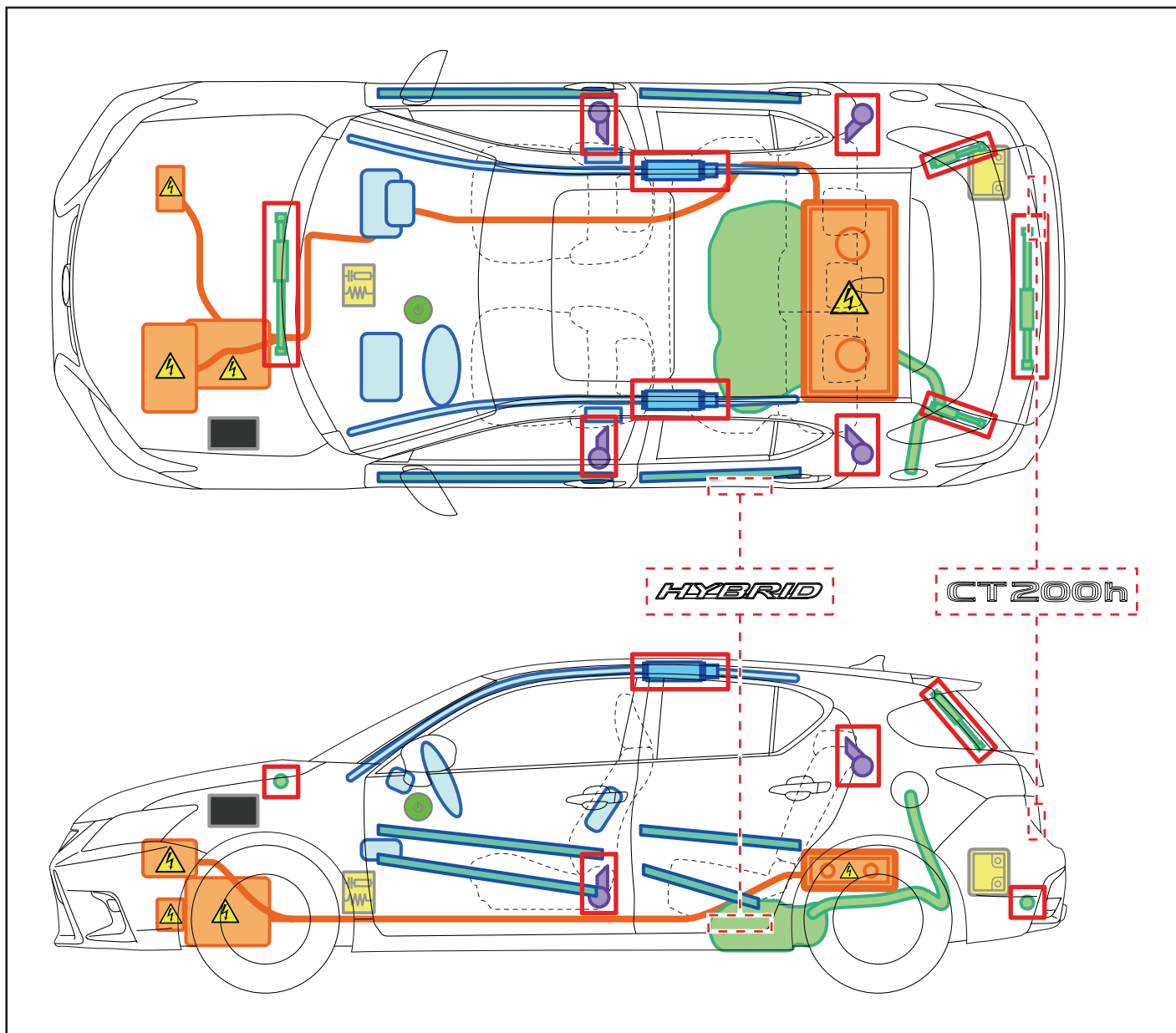



2013-12



LEXUS

LEXUS
HYBRID
DRIVE



	Wyłącznik zapłonu/ Przycisk rozruchu		Skrzynka bezpieczników		Akumulator 12V
	Poduszka powietrzna (w tym napełniacz)		Generator gazu		Akumulator wysokonapięciowy
	Obwód wysokiego napięcia		Zbiornik paliwa		Sprężyna gazowa
	Napinacz pasa bezpieczeństwa		Wzmocnienie nadwozia		Sterownik
-	-	-	-	-	-

Zabezpieczenie pojazdu

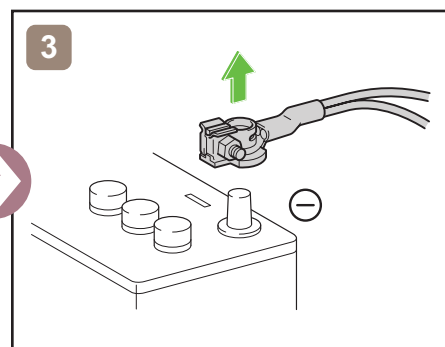
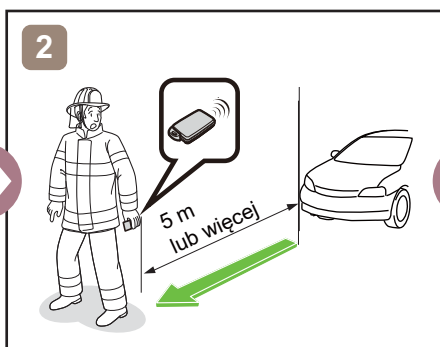
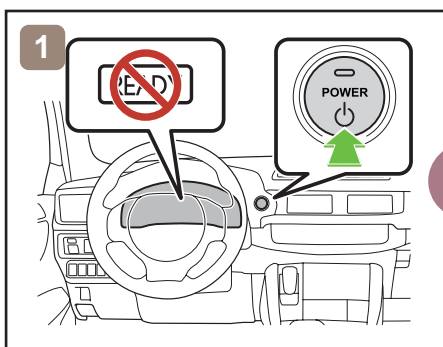

lub

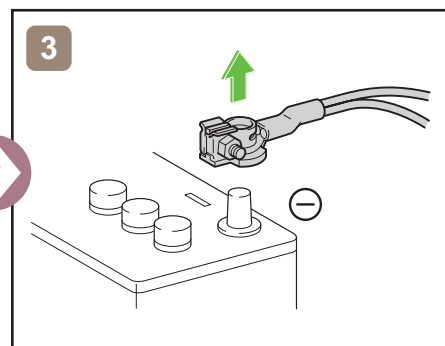
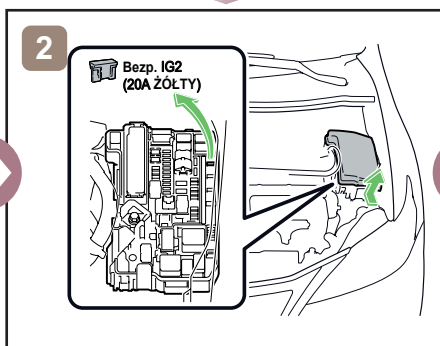
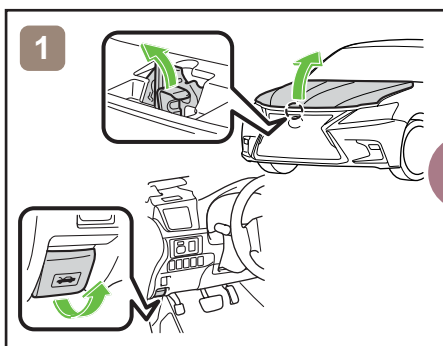

Dostęp do akumulatora 12V

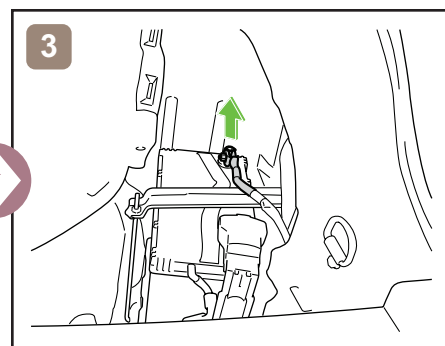
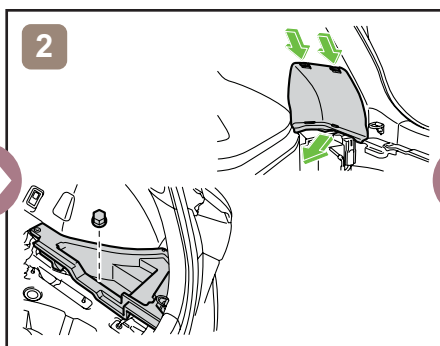
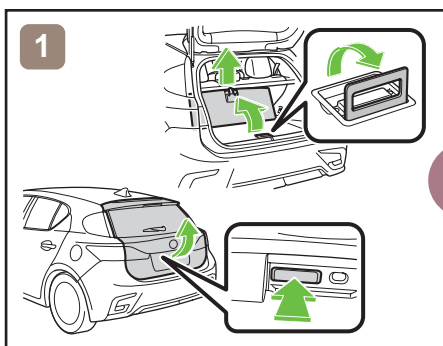

Holowanie pojazdu

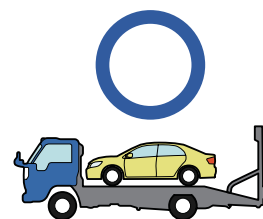
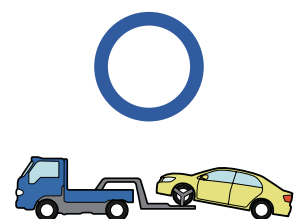
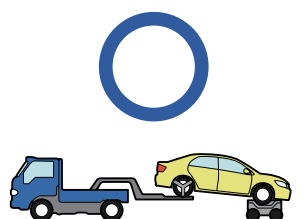
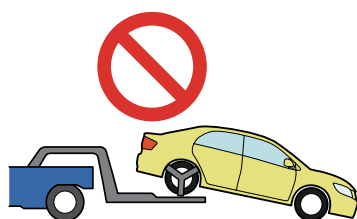

ES300h

LHD



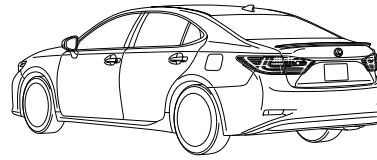
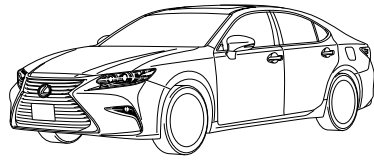





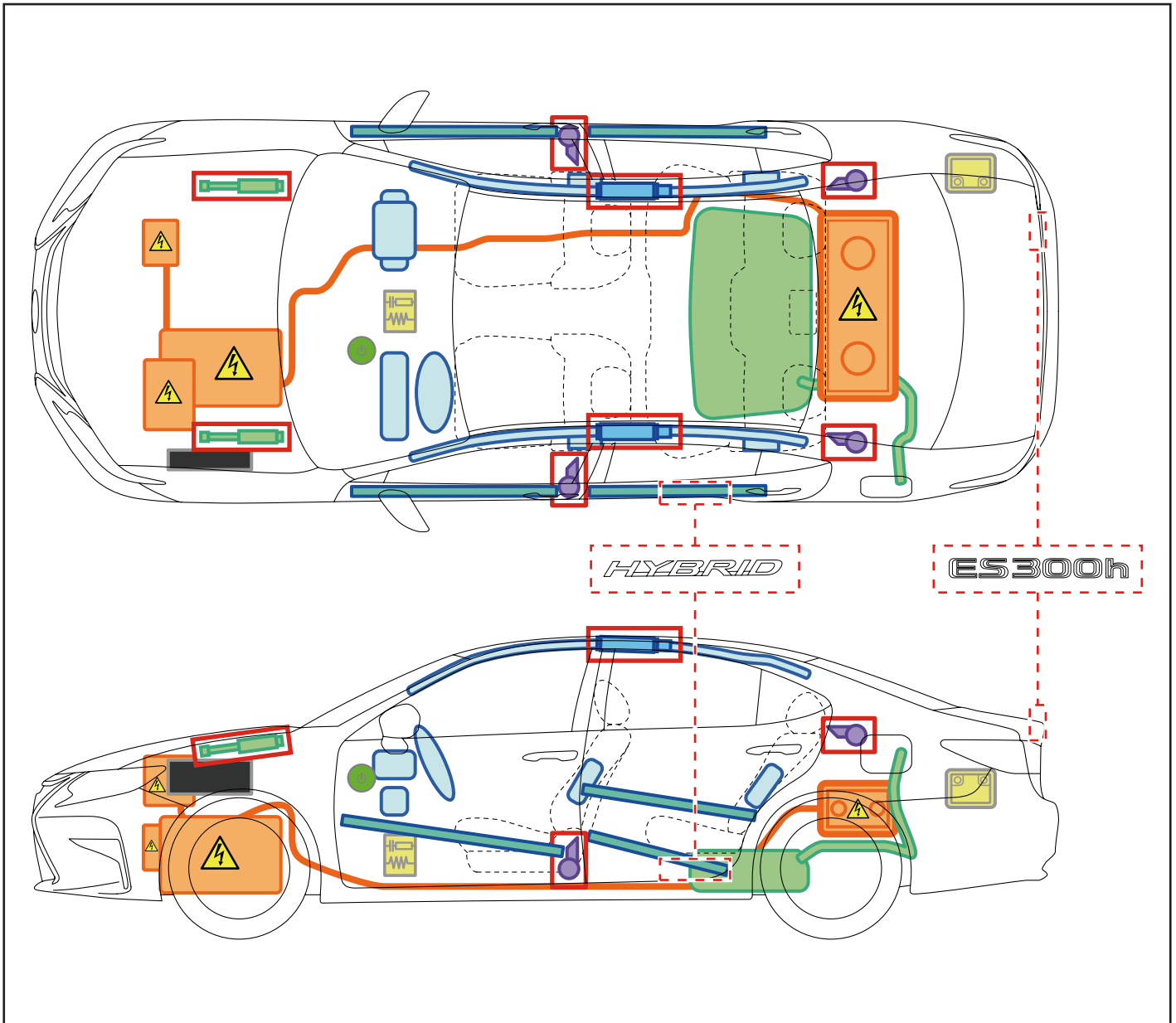



2015-7



LEXUS

LEXUS
HYBRID
DRIVE



	Wyłącznik zapłonu/ Przycisk rozruchu		Skrzynka bezpieczników		Akumulator 12V
	Poduszka powietrzna (w tym napełniacz)		Generator gazu		Akumulator wysokonapięciowy
	Obwód wysokiego napięcia		Zbiornik paliwa		Sprężyna gazowa
	Napinacz pasa bezpieczeństwa		Wzmocnienie nadwozia		Sterownik
-	-	-	-	-	-

Zabezpieczenie pojazdu

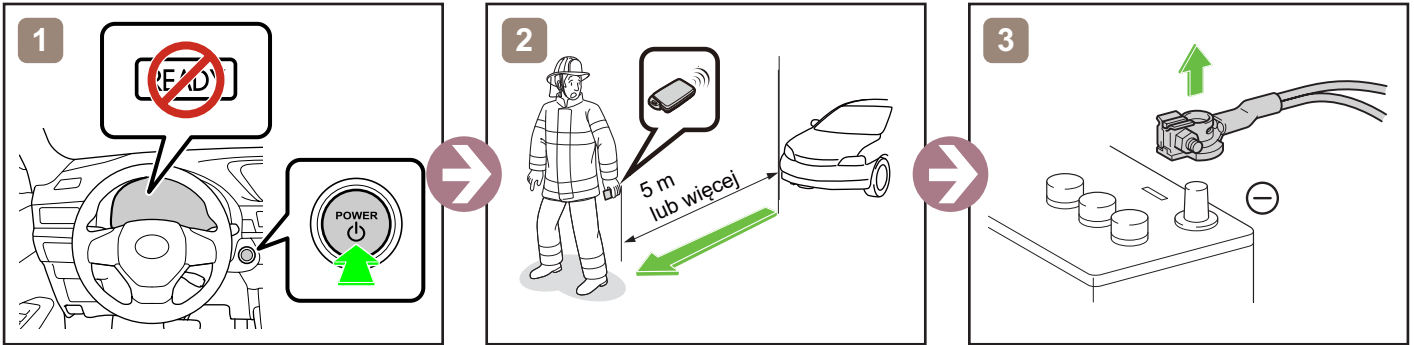

lub

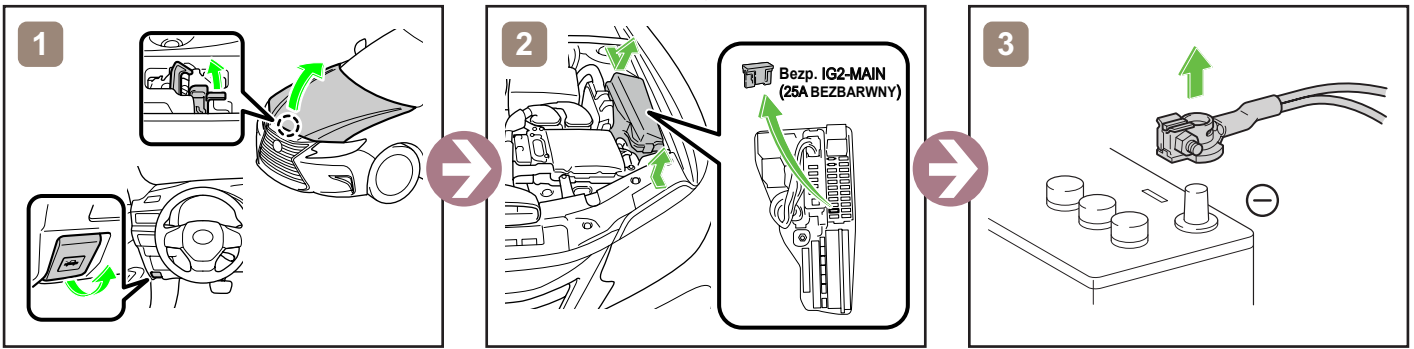

Dostęp do akumulatora 12V

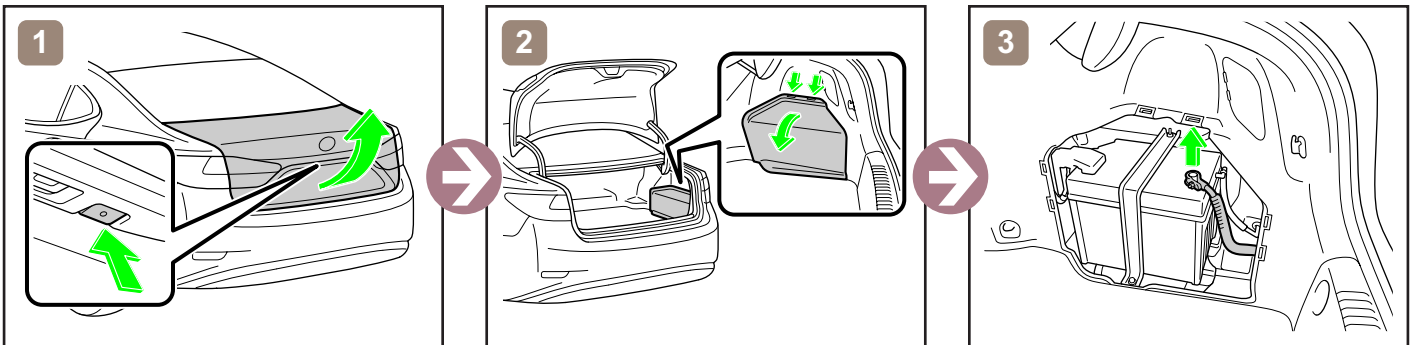

Holowanie pojazdu

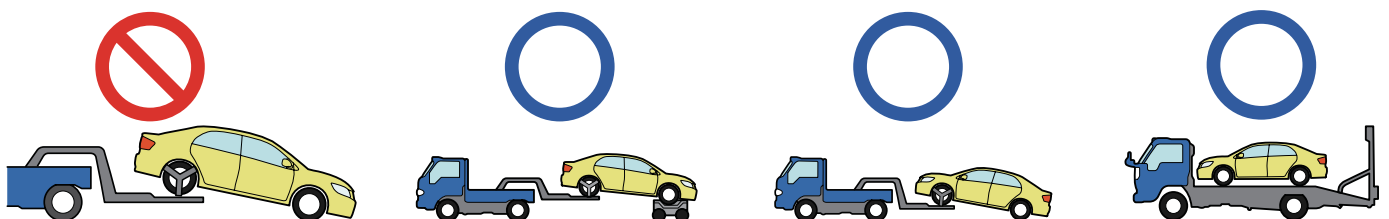

NX300h

LHD

2014-7



**LEXUS
HYBRID
DRIVE**

**HV BATTERY
Ni-MH**

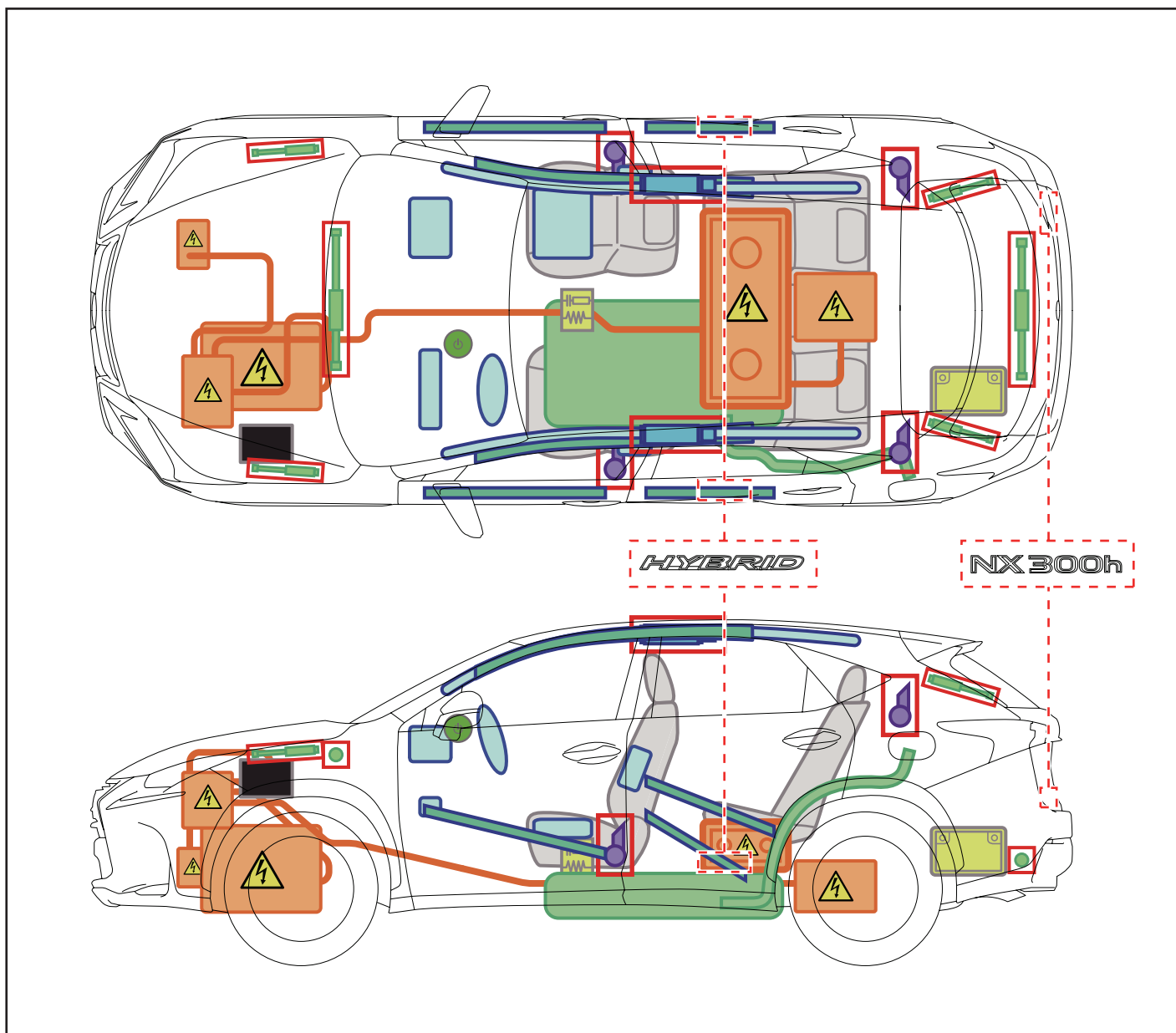

	Wyłącznik zapłonu/ Przycisk rozruchu		Skrzynka bezpieczników		Akumulator 12V
	Poduszka powietrzna (w tym napełniacz)		Generator gazu		Akumulator wysokonapięciowy
	Obwód wysokiego napięcia		Zbiornik paliwa		Sprężyna gazowa
	Napinacz pasa bezpieczeństwa		Wzmocnienie nadwozia		Sterownik
—	—	—	—	—	—

Zabezpieczenie pojazdu

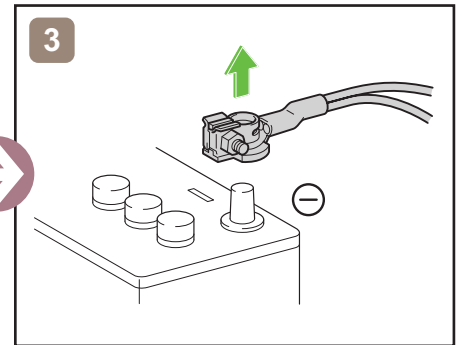
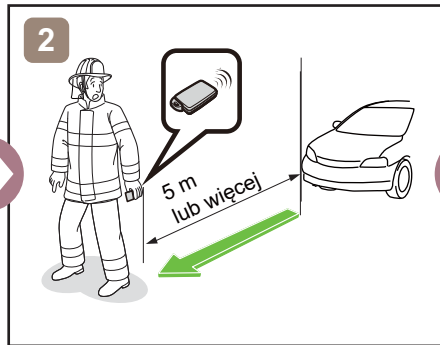
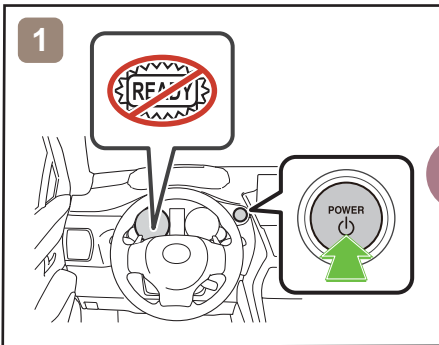

lub

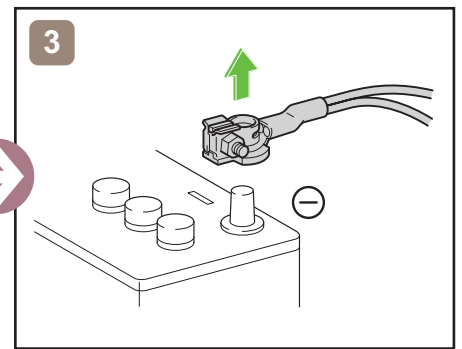
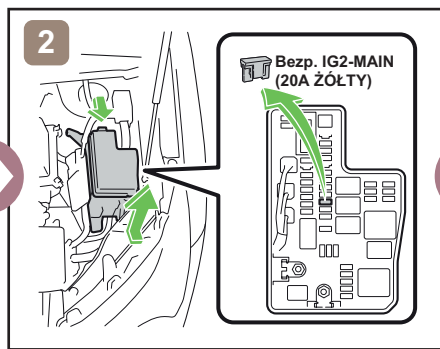
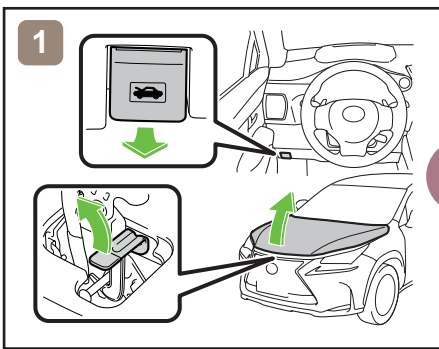

Dostęp do akumulatora 12V

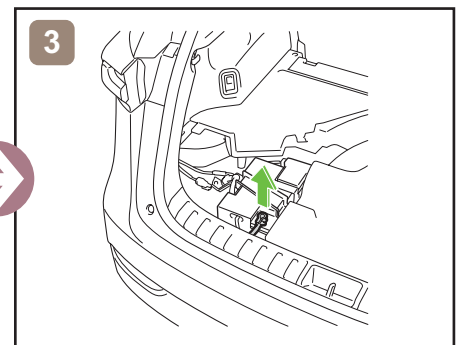
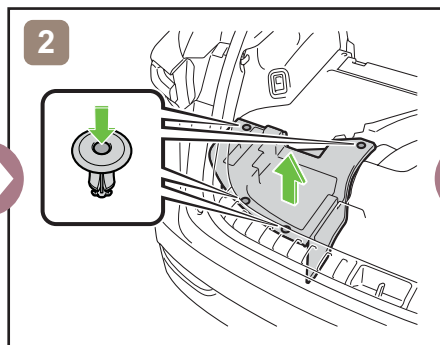
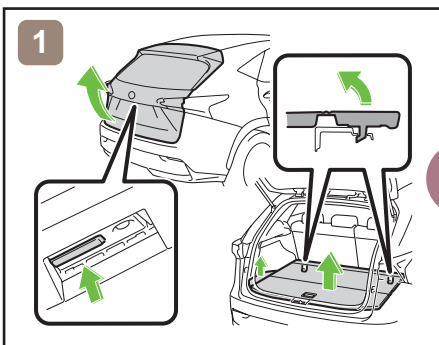

Holowanie pojazdu

