

mapa podstawowa





Stan na: 09-10-2023
Skala 1:1500

b
1.99

i
0.44

r
1.24

j
0.22

Szkic	
	Grunty
Wody	
	Rowy
Obiekty liniowe	
	Linie podziału powierzchniowego
	Inne obiekty infrastruktury

mapa podstawowa

Stan na: 09-10-2023
Skala 1:1500

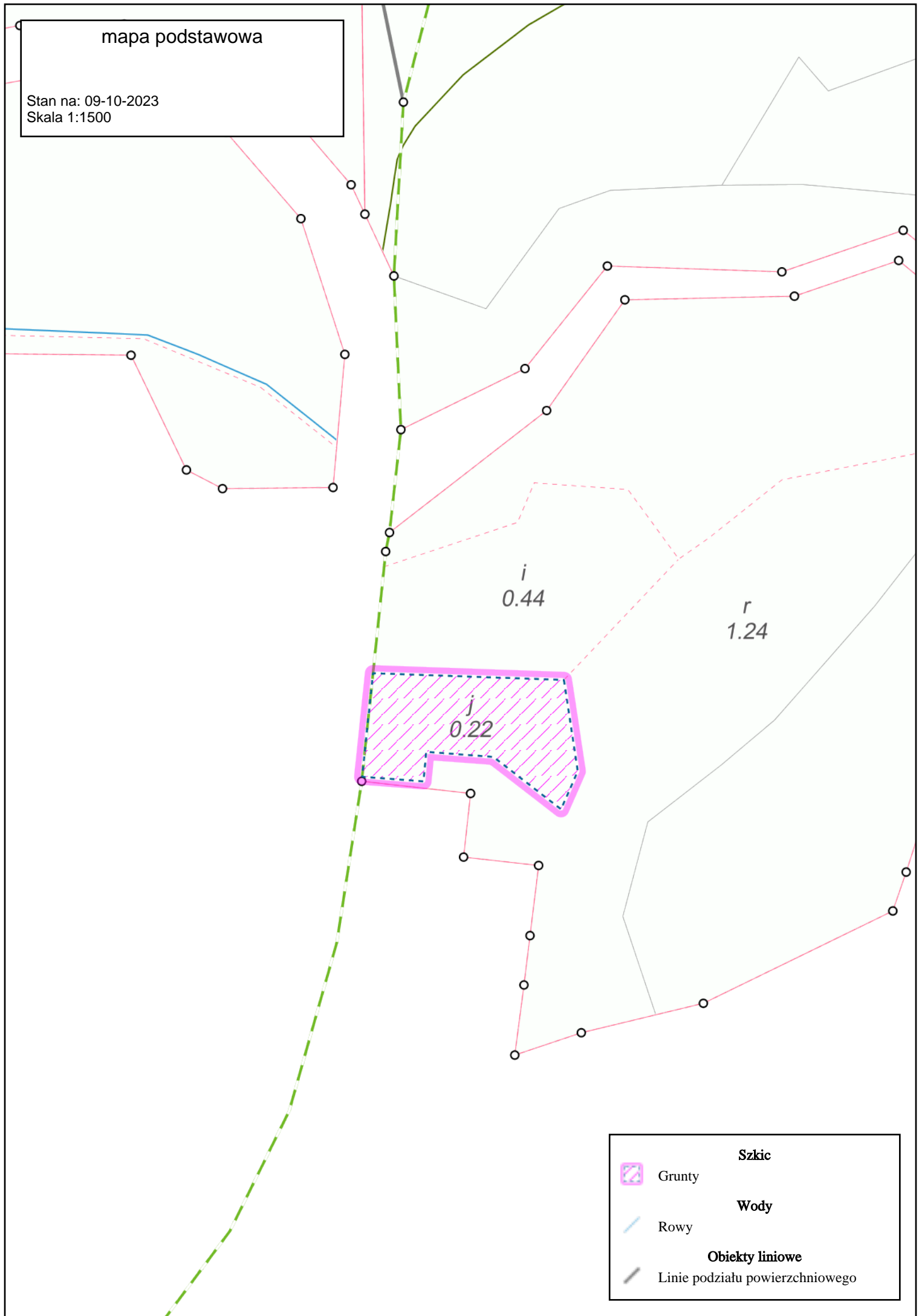

i
0.44

r
1.24

j
0.22

Szkic

 Grunty

Wody

 Rowy

Obiekty liniowe

 Linie podziału powierzchniowego

mapa podstawowa

Stan na: 10-10-2023
Skala 1:1500

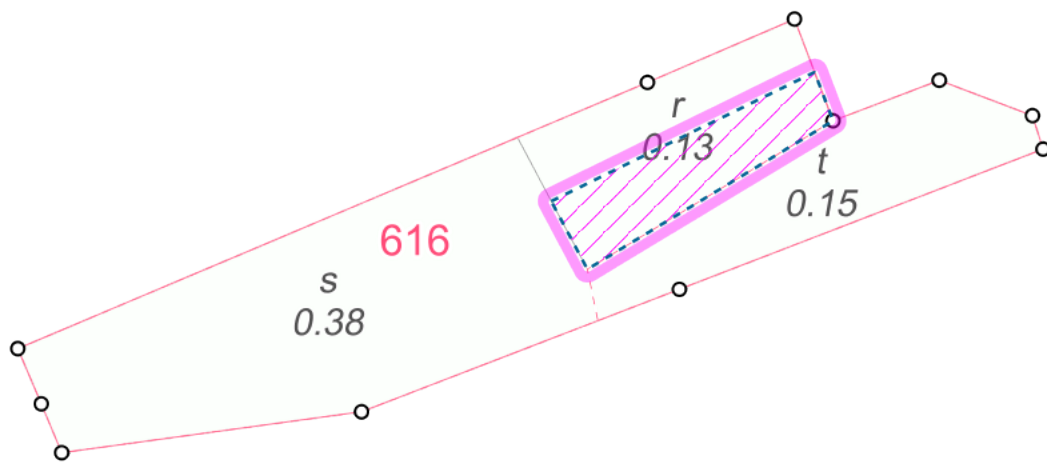

Grunty

Szkic

mapa podstawowa

Stan na: 10-10-2023
Skala 1:1500

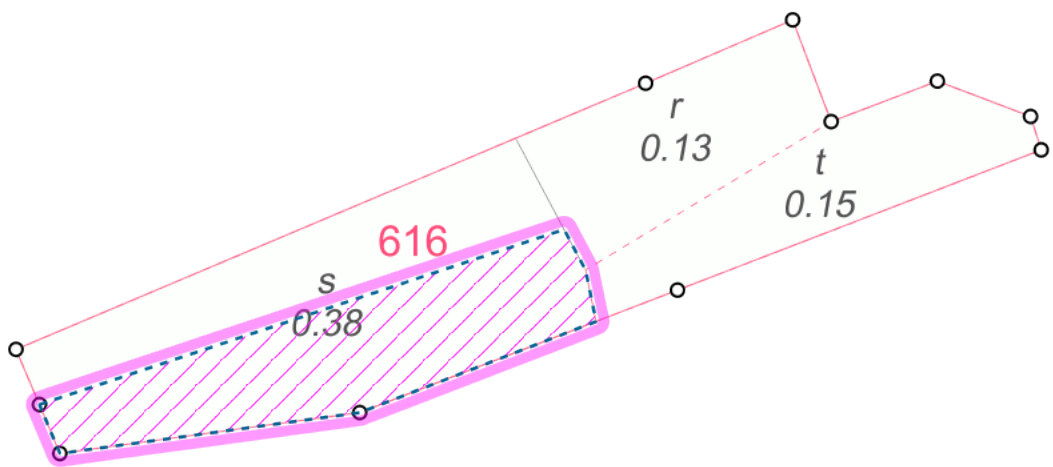

Grunty

Szkic

mapa podstawowa

Stan na: 09-10-2023
Skala 1:1500

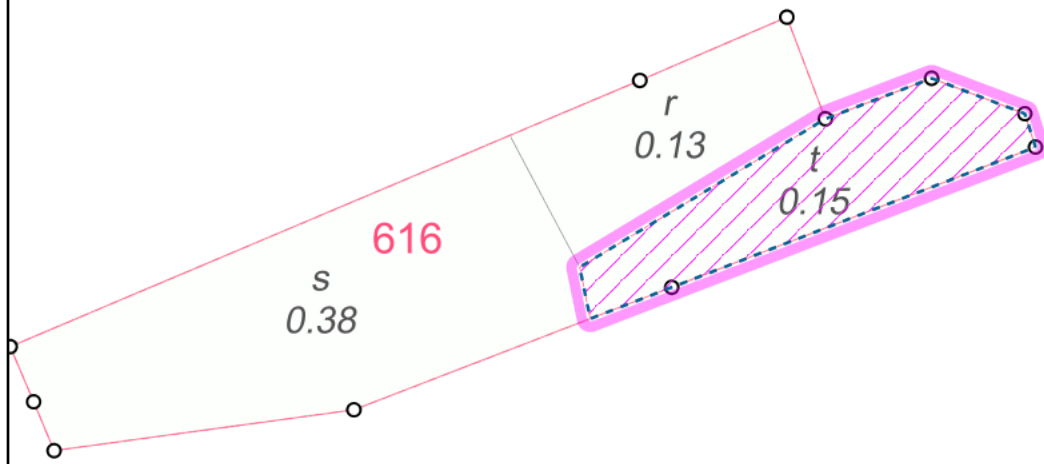

 Grunty

Szkiec

mapa podstawowa

Stan na: 10-10-2023
Skala 1:1500

0.42

r
0.16

dx
0.02

x
0.74

PCW-04/05



c
0.18

d
0.23

b
0.90

a
0.69

g
0.09

bx
0.18

b
0.19

345
344
cx
0.09

m
0.61

c
0.29

d
0.90

f
0.17

Szkic

- Grunty
- Obiekty punktowe**
 - Obiekty inwentarzowe
 - Punkt czerpania wody
- Obiekty liniowe**
 - Linie energetyczne

mapa podstawowa

Stan na: 09-10-2023
Skala 1:1500

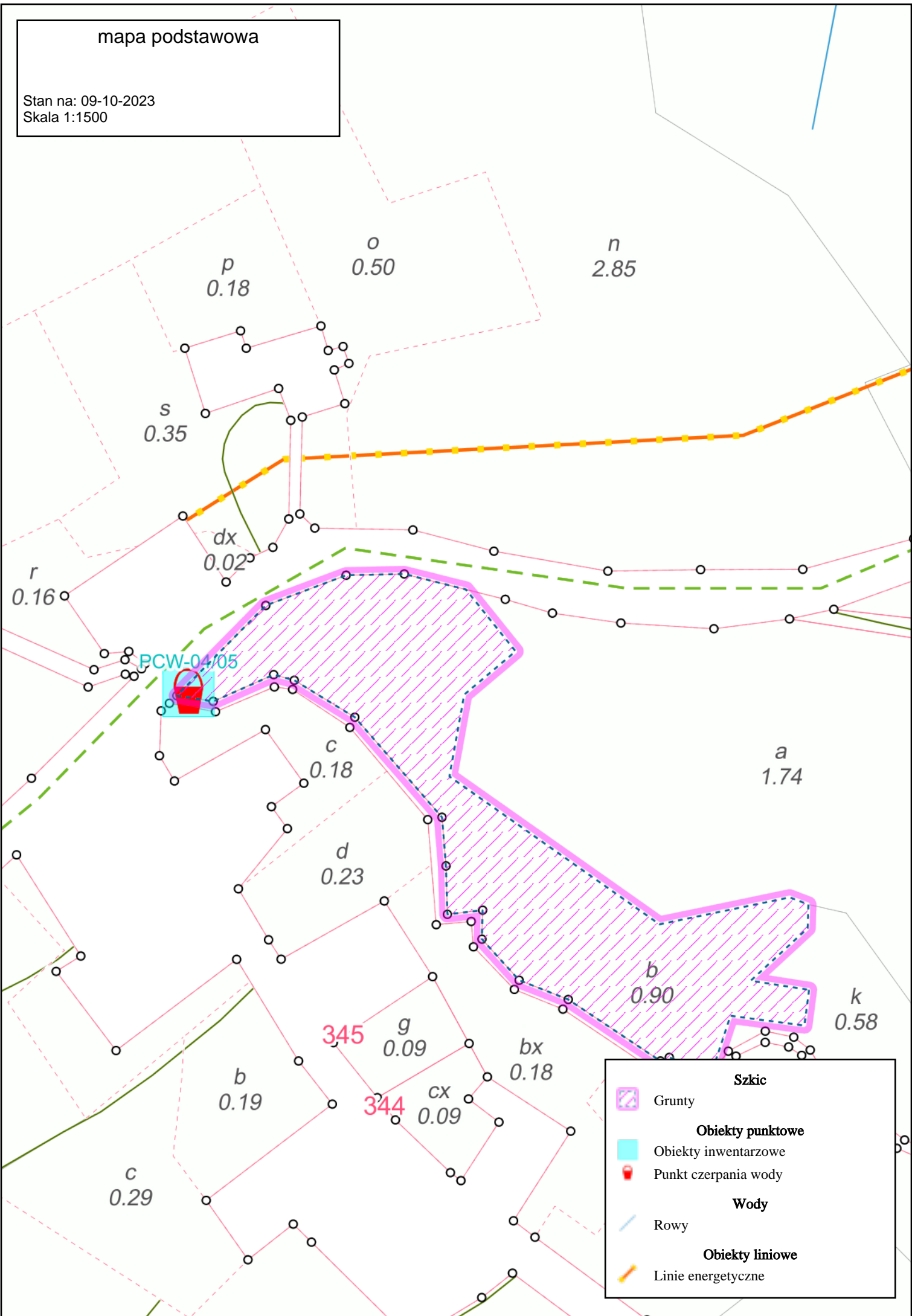

Szkic

- Grunty
- Obiekty punktowe**
- Obiekty inwentarzowe
- Punkt czerpania wody
- Wody**
- Rowy
- Obiekty liniowe**
- Linie energetyczne

mapa podstawowa

Stan na: 09-10-2023
Skala 1:1500

a
2.91

388

p
0.15

d
4.17

f
0.99

h
0.10

i
1.44

j
0.25
109/81

110/80

	Grunty	Szkic
	Rowy	Wody
	Linie energetyczne	Obiekty liniowe
	Obiekty inwentarzowe	Budynki
	Budynki	

mapa podstawowa

Stan na: 09-10-2023
Skala 1:1500

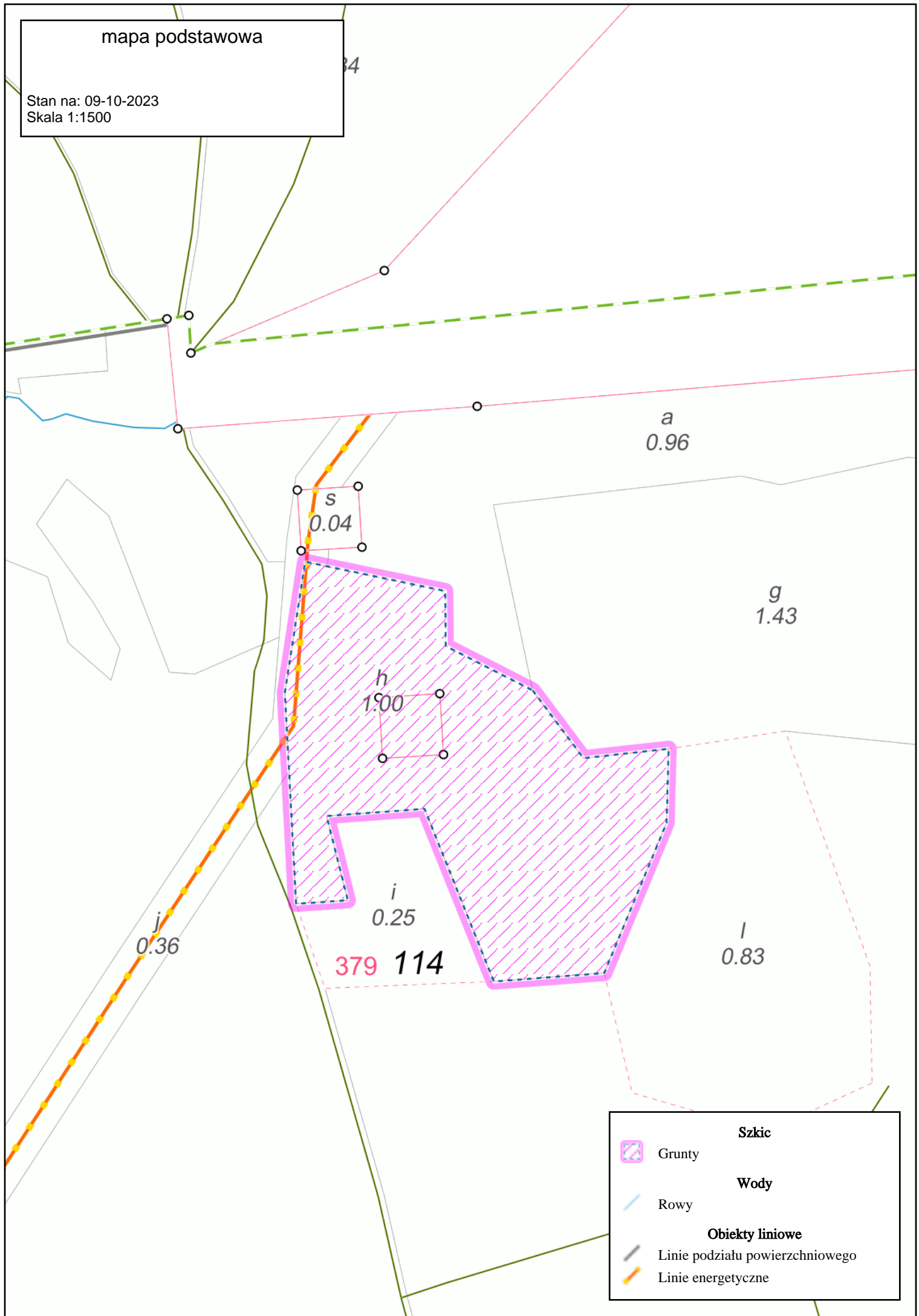

mapa podstawowa

Stan na: 10-10-2023
Skala 1:1500

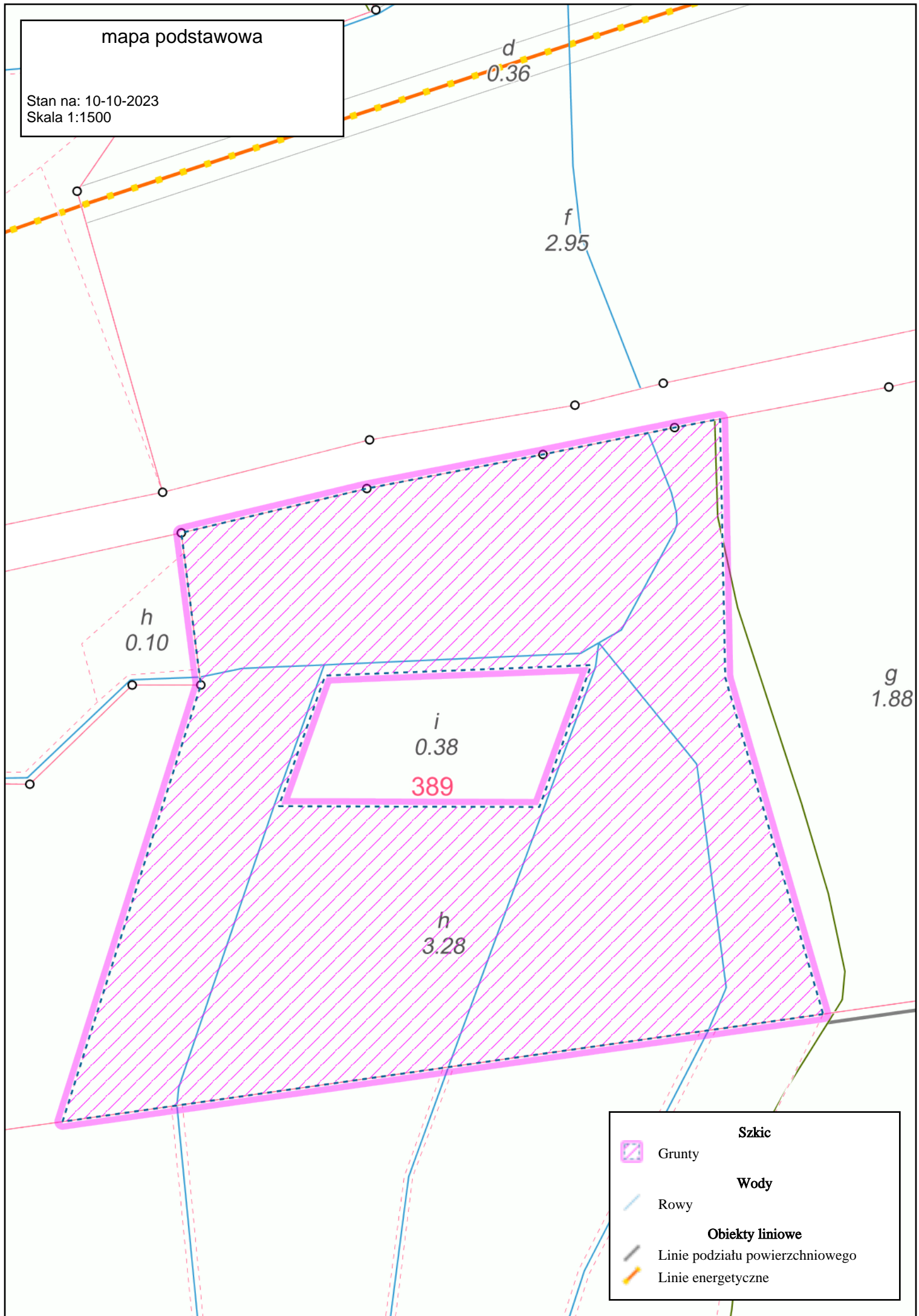

- Szkic**
- Grunty
 - Rowy
 - Linie podziału powierzchniowego
 - Linie energetyczne
- Wody**
- Obiekty liniowe**

mapa podstawowa

Stan na: 09-10-2023
Skala 1:1500

c
0.92

a
6.52

d
1.03



223/223



f
0.80



g
1.45

j
0.23

k
0.51

Szkic	
	Grunty
	Rowy
	Linie podziału powierzchniowego

Wody	
	Grunty
	Rowy
	Linie podziału powierzchniowego

Obiekty liniowe	
	Grunty
	Rowy
	Linie podziału powierzchniowego

mapa podstawowa

Stan na: 09-10-2023
Skala 1:1500

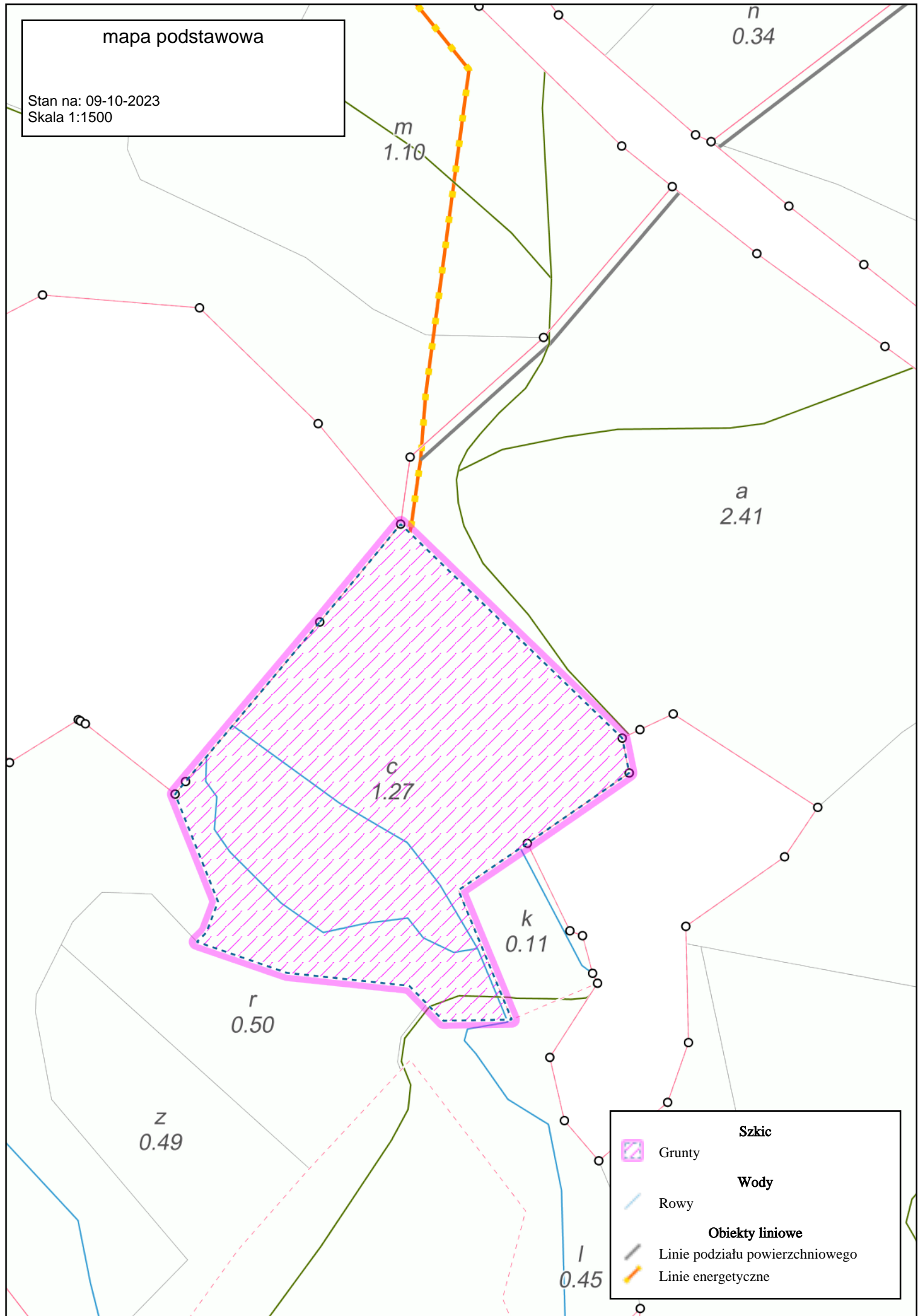

Szkic	
	Grunty
Wody	
	Rowy
Obiekty liniowe	
	Linie podziału powierzchniowego
	Linie energetyczne

mapa podstawowa

Stan na: 09-10-2023
Skala 1:1500

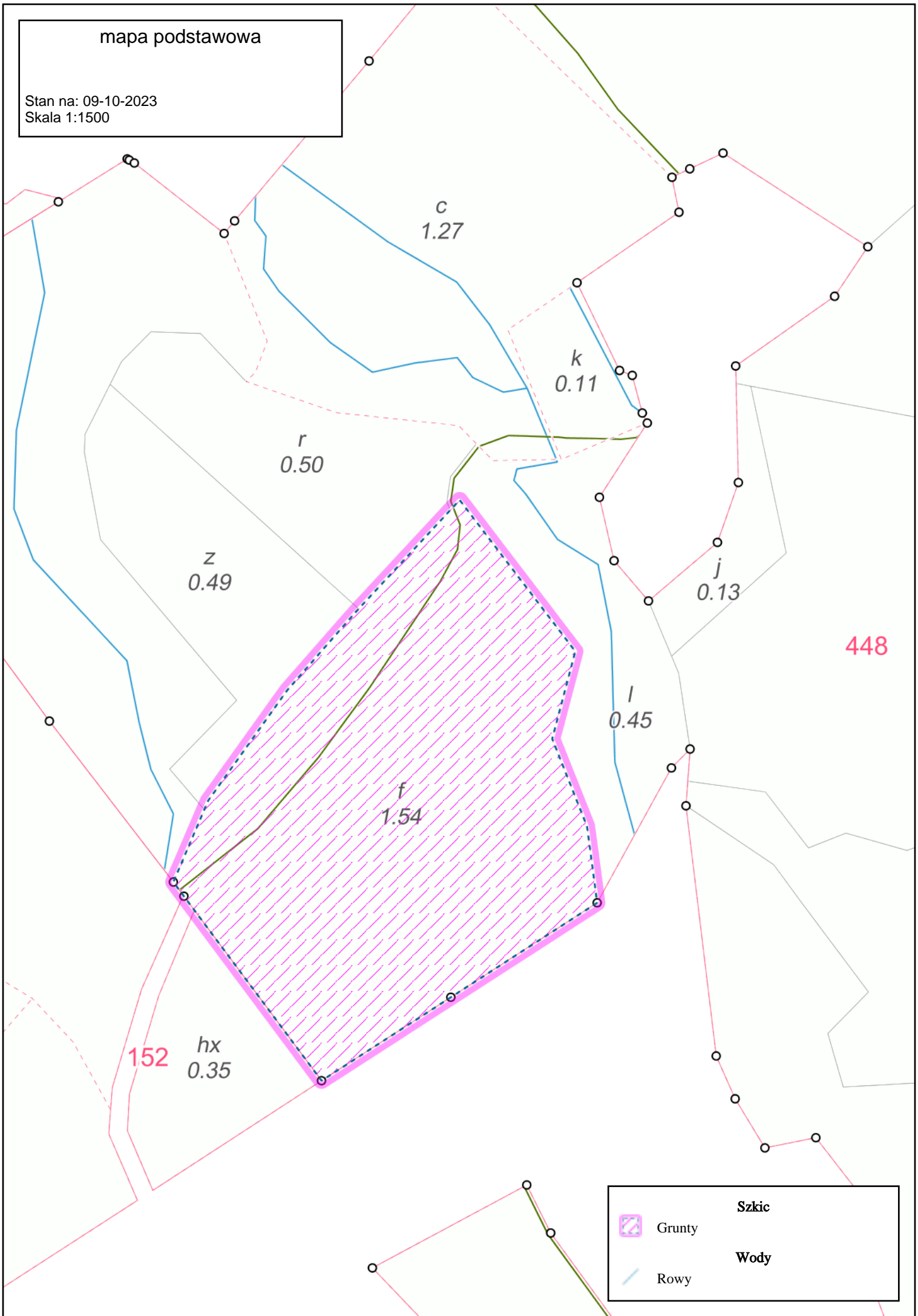

mapa podstawowa

Stan na: 09-10-2023
Skala 1:1500

324

h
1.72

p
0.18

o
0.50

t
0.42

s
0.35

cx
0.38

r
0.16

dx
0.02

PCW-04/05

x
0.74

c
0.18

ax
0.18

d
0.23





a
0.69

345

b
0.10

d
0.90

Szkic

-  Grunty
- Obiekty punktowe**
-  Obiekty inwentarzowe
-  Punkt czerpania wody
- Wody**
-  Rowy
- Obiekty liniowe**
-  Linie energetyczne