

## Schema Schemat\_ITP(1)\_v1-0.xsd

schema location: [d:\AVLM\Documents\REPORTER\\_2022\Schemat ITP\(1\)\\_v1-0.xsd](d:\AVLM\Documents\REPORTER_2022\Schemat ITP(1)_v1-0.xsd)  
attributeFormDefault: **unqualified**  
elementFormDefault: **qualified**  
targetNamespace: <http://itp.mf.gov.pl/wzor/2022/08/04/08042/>

Elements	Complex types	Simple types
<a href="#">ITP</a>	<a href="#">TAdres</a>	<a href="#">TData</a>
	<a href="#">TAdresPolskiITP</a>	<a href="#">TKodFormularza</a>
	<a href="#">TIdentyfikatorOsobyFizycznej</a>	<a href="#">TKodPocztowyPL</a>
	<a href="#">TIdentyfikatorOsobyNiefizycznej</a>	<a href="#">TKwotowy</a>
	<a href="#">TIdentyfikatorOsobyNiefizycznej1</a>	<a href="#">TNrRBITP</a>
	<a href="#">TNaglowek</a>	<a href="#">TZnakowyITP</a>
	<a href="#">TOsobaNiefizyczna</a>	
	<a href="#">TOsobaNiefizyczna1</a>	
	<a href="#">TPodmiotDowolny</a>	
	<a href="#">TPodmiotDowolnyBezAdresu</a>	

element ITP

<p>diagram</p>	<p><b>ITP</b> INFORMACJA O TRANSAKCIJCH PŁATNICZYCH PRZY UŻYCIU TERMINALI PŁATNICZYCH</p> <ul style="list-style-type: none"> <li><b>tns:Naglowek</b> Nagłówek informacji</li> <li><b>tns:Podmiot1</b> Dane Agenta rozliczeniowego</li> <li><b>tns:Podmiot2</b> Dane Akceptanta oraz dotyczące terminali płatniczych 1..∞</li> <li><b>tns:Pouczenia</b> Pouczenia dla agenta. Wartość 1 oznacza potwierdzenie zapoznania się z treścią i akceptację poniższych pouczeń: <ul style="list-style-type: none"> <li>1. Wypełnianie obowiązków, o których mowa w art. 278b, podlega kontroli wykonywanej przez Szefa Krajowej Administracji Skarbowej.</li> <li>2. Zgodnie z treścią przepisu art. 278e ustawy o zmianie niektórych ustaw w celu automatyzacji załatwiania niektórych spraw przez Krajową Administrację Skarbową agent rozliczeniowy, który nie dopełnia obowiązku przekazania Szefowi Krajowej Administracji Skarbowej w terminie określonym w art. 278b ust. 3 informacji, o której mowa w art. 278b ust. 1, przekazuje tę informację w niepełnym zakresie lub niezgodną z posiadanymi informacjami lub danymi lub niezgodnie z wymaganiami określonymi w art. 49aa ust. 4, podlega karze pieniężnej. Karę pieniężną nadaje Szef Krajowej Administracji Skarbowej w drodze decyzji. Od decyzji przysługuje wniosek o ponowne rozpatrzenie sprawy w ter...</li> </ul> </li> </ul>
<p>namespace</p>	<p><a href="http://itp.mf.gov.pl/wzor/2022/08/04/08042/">http://itp.mf.gov.pl/wzor/2022/08/04/08042/</a></p>
<p>properties</p>	<p>content complex</p>
<p>children</p>	<p><a href="#">tns:Naglowek</a> <a href="#">tns:Podmiot1</a> <a href="#">tns:Podmiot2</a> <a href="#">tns:Pouczenia</a></p>
<p>annotation</p>	<p>documentation INFORMACJA O TRANSAKCIJCH PŁATNICZYCH PRZY UŻYCIU TERMINALI PŁATNICZYCH</p>

element **ITP/Naglowek**

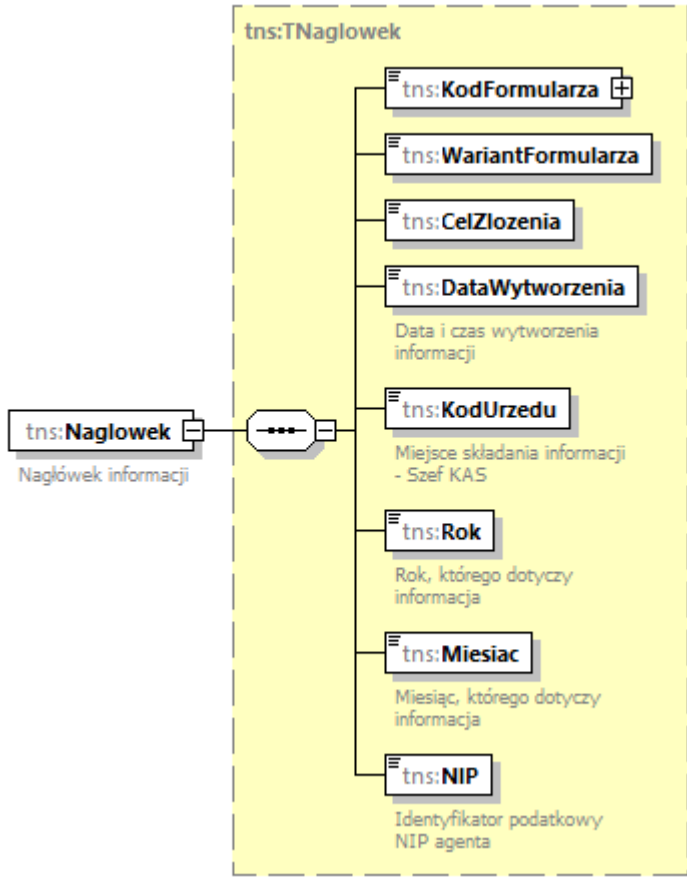
<p>diagram</p>	
<p>namespace</p>	<p><a href="http://itp.mf.gov.pl/wzor/2022/08/04/08042/">http://itp.mf.gov.pl/wzor/2022/08/04/08042/</a></p>
<p>type</p>	<p><a href="#">tns:TNaglowek</a></p>
<p>properties</p>	<p>content complex</p>
<p>children</p>	<p><a href="#">tns:KodFormularza</a> <a href="#">tns:WariantFormularza</a> <a href="#">tns:CelZlozenia</a> <a href="#">tns:DataWytworzenia</a> <a href="#">tns:KodUrzedu</a> <a href="#">tns:Rok</a> <a href="#">tns:Miesiac</a> <a href="#">tns:NIP</a></p>
<p>annotation</p>	<p>documentation Nagłówek informacji</p>

element **ITP/Podmiot1**

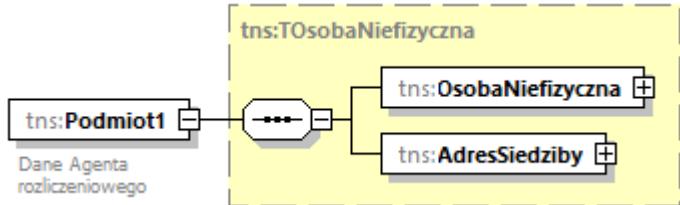
<p>diagram</p>	
<p>namespace</p>	<p><a href="http://itp.mf.gov.pl/wzor/2022/08/04/08042/">http://itp.mf.gov.pl/wzor/2022/08/04/08042/</a></p>

type	<a href="#">tns:TOsobaNiefizyczna</a>
properties	content complex
children	<a href="#">tns:OsobaNiefizyczna</a> <a href="#">tns:AdresSiedziby</a>
annotation	documentation Dane Agenta rozliczeniowego

element **ITP/Podmiot2**

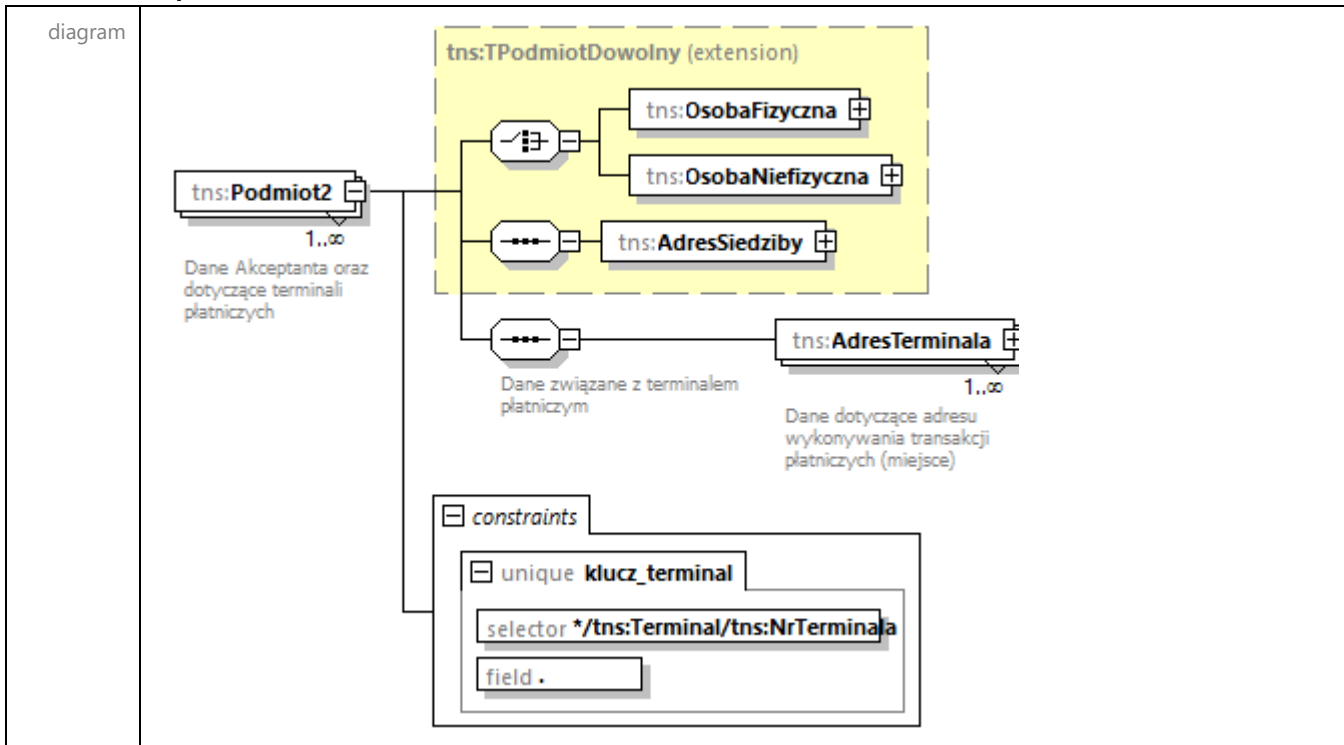

namespace	http://itp.mf.gov.pl/wzor/2022/08/04/08042/					
type	extension of <a href="#">tns:TPodmiotDowolny</a>					
properties	minOcc	1	maxOcc	unbounded	content	complex
children	<a href="#">tns:OsobaFizyczna</a> <a href="#">tns:OsobaNiefizyczna</a> <a href="#">tns:AdresSiedziby</a> <a href="#">tns:AdresTerminala</a>					
identity constraints	unique	Name	Refer	Selector	Field(s)	Annotation
		klucz_terminal		* /tns:Terminal/tns:NrTerminala	.	
annotation	documentation Dane Akceptanta oraz dotyczące terminali płatniczych					

element **ITP/Podmiot2/AdresTerminala**

<p>diagram</p>	<p><b>tns:AdresTerminala</b> 1..∞ Dane dotyczące adresu wykonywania transakcji płatniczych (miejsce)</p> <p><b>tns:TAdresPolskiITP (extension)</b></p> <ul style="list-style-type: none"> <li><b>tns:KodKraju</b> Kraj</li> <li><b>tns:Wojewodztwo</b> Województwo</li> <li><b>tns:Ulica</b> Nazwa ulicy</li> <li><b>tns:NrDomu</b> Numer budynku</li> <li><b>tns:NrLokalu</b> Numer lokalu</li> <li><b>tns:Miejscowosc</b> Nazwa miejscowości</li> <li><b>tns:KodPocztowy</b> Kod pocztowy</li> </ul> <p><b>tns:Terminal</b> 1..∞ Dane dotyczące terminala płatniczego oraz transakcji płatniczych</p>
<p>namespace</p>	<p><a href="http://itp.mf.gov.pl/wzor/2022/08/04/08042/">http://itp.mf.gov.pl/wzor/2022/08/04/08042/</a></p>
<p>type</p>	<p>extension of <a href="#">tns:TAdresPolskiITP</a></p>
<p>properties</p>	<p>minOcc 1 maxOcc unbounded content complex</p>
<p>children</p>	<p><a href="#">tns:KodKraju</a> <a href="#">tns:Wojewodztwo</a> <a href="#">tns:Ulica</a> <a href="#">tns:NrDomu</a> <a href="#">tns:NrLokalu</a> <a href="#">tns:Miejscowosc</a> <a href="#">tns:KodPocztowy</a> <a href="#">tns:Terminal</a></p>
<p>annotation</p>	<p>documentation Dane dotyczące adresu wykonywania transakcji płatniczych (miejsce)</p>

element **ITP/Podmiot2/AdresTerminala/Terminal**

diagram	<p><b>tns:Terminal</b> 1..∞ Dane dotyczące terminala płatniczego oraz transakcji płatniczych</p> <p>Dane dotyczące terminala płatniczego</p> <p><b>tns:Transakcje</b> + Dane dotyczące transakcji płatniczych akceptanta</p> <p><b>tns:NrTerminala</b> Numer identyfikacyjny terminala płatniczego</p> <p><b>tns:NrRachunku</b> Numer rachunku akceptanta powiązanego z terminalem płatniczym</p> <p><b>tns:DataOd</b> Data, od której rachunek akceptanta jest powiązany z terminalem płatniczym</p> <p><b>tns:DataDo</b> Data, do której rachunek akceptanta był powiązany z terminalem płatniczym</p>
namespace	http://itp.mf.gov.pl/wzor/2022/08/04/08042/
properties	minOcc 1 maxOcc unbounded content complex
children	<a href="#">tns:NrTerminala</a> <a href="#">tns:NrRachunku</a> <a href="#">tns:DataOd</a> <a href="#">tns:DataDo</a> <a href="#">tns:Transakcje</a>
annotation	documentation Dane dotyczące terminala płatniczego oraz transakcji płatniczych

element **ITP/Podmiot2/AdresTerminala/Terminal/NrTerminala**

diagram	<p><b>tns:NrTerminala</b> Numer identyfikacyjny terminala płatniczego</p>									
namespace	http://itp.mf.gov.pl/wzor/2022/08/04/08042/									
type	restriction of <a href="#">tns:TZnakowyITP</a>									
properties	content simple									
facets	<table border="1"> <thead> <tr> <th>Kind</th> <th>Value</th> <th>Annotation</th> </tr> </thead> <tbody> <tr> <td>minLength</td> <td>1</td> <td></td> </tr> <tr> <td>maxLength</td> <td>8</td> <td></td> </tr> </tbody> </table>	Kind	Value	Annotation	minLength	1		maxLength	8	
Kind	Value	Annotation								
minLength	1									
maxLength	8									
annotation	documentation Numer identyfikacyjny terminala płatniczego									

element **ITP/Podmiot2/AdresTerminala/Terminal/NrRachunku**

diagram	 <p>Numer rachunku akceptanta powiązanego z terminalem płatniczym</p>						
namespace	http://itp.mf.gov.pl/wzor/2022/08/04/08042/						
type	<a href="#">tns:TNRBITP</a>						
properties	content simple						
facets	<table border="0"> <thead> <tr> <th>Kind</th> <th>Value</th> <th>Annotation</th> </tr> </thead> <tbody> <tr> <td>pattern</td> <td>[0-9A-Z]{10,32}</td> <td></td> </tr> </tbody> </table>	Kind	Value	Annotation	pattern	[0-9A-Z]{10,32}	
Kind	Value	Annotation					
pattern	[0-9A-Z]{10,32}						
annotation	documentation Numer rachunku akceptanta powiązanego z terminalem płatniczym						

element **ITP/Podmiot2/AdresTerminala/Terminal/DataOd**

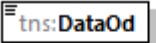
diagram	 <p>Data, od której rachunek akceptanta jest powiązany z terminalem płatniczym</p>												
namespace	http://itp.mf.gov.pl/wzor/2022/08/04/08042/												
type	<a href="#">tns:TData</a>												
properties	content simple												
facets	<table border="0"> <thead> <tr> <th>Kind</th> <th>Value</th> <th>Annotation</th> </tr> </thead> <tbody> <tr> <td>minInclusive</td> <td>1990-01-01</td> <td></td> </tr> <tr> <td>maxInclusive</td> <td>2050-12-31</td> <td></td> </tr> <tr> <td>pattern</td> <td>((\d{4})-(\d{2})-(\d{2}))</td> <td></td> </tr> </tbody> </table>	Kind	Value	Annotation	minInclusive	1990-01-01		maxInclusive	2050-12-31		pattern	((\d{4})-(\d{2})-(\d{2}))	
Kind	Value	Annotation											
minInclusive	1990-01-01												
maxInclusive	2050-12-31												
pattern	((\d{4})-(\d{2})-(\d{2}))												
annotation	documentation Data, od której rachunek akceptanta jest powiązany z terminalem płatniczym												

element **ITP/Podmiot2/AdresTerminala/Terminal/DataDo**

diagram	 <p>Data, do której rachunek akceptanta był powiązany z terminalem płatniczym</p>												
namespace	http://itp.mf.gov.pl/wzor/2022/08/04/08042/												
type	<a href="#">tns:TData</a>												
properties	content simple												
facets	<table border="0"> <thead> <tr> <th>Kind</th> <th>Value</th> <th>Annotation</th> </tr> </thead> <tbody> <tr> <td>minInclusive</td> <td>1990-01-01</td> <td></td> </tr> <tr> <td>maxInclusive</td> <td>2050-12-31</td> <td></td> </tr> <tr> <td>pattern</td> <td>((\d{4})-(\d{2})-(\d{2}))</td> <td></td> </tr> </tbody> </table>	Kind	Value	Annotation	minInclusive	1990-01-01		maxInclusive	2050-12-31		pattern	((\d{4})-(\d{2})-(\d{2}))	
Kind	Value	Annotation											
minInclusive	1990-01-01												
maxInclusive	2050-12-31												
pattern	((\d{4})-(\d{2})-(\d{2}))												
annotation	documentation Data, do której rachunek akceptanta był powiązany z terminalem płatniczym												

element **ITP/Podmiot2/AdresTerminala/Terminal/Transakcje**

diagram	
namespace	http://itp.mf.gov.pl/wzor/2022/08/04/08042/
properties	content complex
children	<a href="#">tns:KodWaluty</a> <a href="#">tns:LiczbaTransakcji</a> <a href="#">tns:WartoscTransakcji</a>
annotation	documentation Dane dotyczące transakcji płatniczych akceptanta

element **ITP/Podmiot2/AdresTerminala/Terminal/Transakcje/KodWaluty**

diagram																												
namespace	http://itp.mf.gov.pl/wzor/2022/08/04/08042/																											
type	<b>kw:TKodWaluty</b>																											
properties	minOcc 1 maxOcc unbounded content simple																											
facets	<table border="1"> <thead> <tr> <th>Kind</th> <th>Value</th> <th>Annotation</th> </tr> </thead> <tbody> <tr> <td>enumeration</td> <td>AED</td> <td>documentation DIRHAM ZEA</td> </tr> <tr> <td>enumeration</td> <td>AFN</td> <td>documentation AFGANI</td> </tr> <tr> <td>enumeration</td> <td>ALL</td> <td>documentation LEK</td> </tr> <tr> <td>enumeration</td> <td>AMD</td> <td>documentation DRAM</td> </tr> <tr> <td>enumeration</td> <td>ANG</td> <td>documentation GULDEN ANTYLI HOLENDERSKICH</td> </tr> <tr> <td>enumeration</td> <td>AOA</td> <td>documentation KWANZA</td> </tr> <tr> <td>enumeration</td> <td>ARS</td> <td>documentation PESO ARGENTYŃSKIE</td> </tr> <tr> <td>enumeration</td> <td>AUD</td> <td>documentation</td> </tr> </tbody> </table>	Kind	Value	Annotation	enumeration	AED	documentation DIRHAM ZEA	enumeration	AFN	documentation AFGANI	enumeration	ALL	documentation LEK	enumeration	AMD	documentation DRAM	enumeration	ANG	documentation GULDEN ANTYLI HOLENDERSKICH	enumeration	AOA	documentation KWANZA	enumeration	ARS	documentation PESO ARGENTYŃSKIE	enumeration	AUD	documentation
Kind	Value	Annotation																										
enumeration	AED	documentation DIRHAM ZEA																										
enumeration	AFN	documentation AFGANI																										
enumeration	ALL	documentation LEK																										
enumeration	AMD	documentation DRAM																										
enumeration	ANG	documentation GULDEN ANTYLI HOLENDERSKICH																										
enumeration	AOA	documentation KWANZA																										
enumeration	ARS	documentation PESO ARGENTYŃSKIE																										
enumeration	AUD	documentation																										



enumeration	AWG	DOLAR AUSTRALIJSKI documentation
enumeration	AZN	GULDEN ARUBAŃSKI documentation
enumeration	BAM	MANAT AZERBEJDŹAŃSKI documentation
enumeration	BBD	MARKA ZAMIENNA documentation
enumeration	BDT	DOLAR BARBADOSKI documentation
enumeration	BGN	TAKA documentation
enumeration	BHD	LEW documentation
enumeration	BIF	DINAR BAHRAJSKI documentation
enumeration	BMD	FRANK BURUNDYJSKI documentation
enumeration	BND	DOLAR BERMUDZKI documentation
enumeration	BOB	DOLAR BRUNEJSKI documentation
enumeration	BRL	BOLIWIANO documentation
enumeration	BSD	REAL documentation
enumeration	BTN	DOLAR BAHAMSKI documentation
enumeration	BWP	NGULTRUM documentation
enumeration	BYN	PULA documentation
enumeration	BZD	RUBEL BIAŁORUSKI documentation
enumeration	CAD	DOLAR BELIZEŃSKI documentation
enumeration	CDF	DOLAR KANADYJSKI documentation
enumeration	CHF	FRANK KONGIJSKI documentation
enumeration	CLP	FRANK SZWAJCARSKI documentation
enumeration	CNY	PESO CHILIJSKIE documentation
enumeration	COP	YUAN RENMINBI documentation
enumeration	CRC	PESO KOLUMBIJSKIE documentation
enumeration	CUC	COLON KOSTARYKAŃSKI documentation
enumeration	CUP	PESO WYMIENIALNE documentation
enumeration	CVE	PESO KUBAŃSKIE documentation
enumeration	CZK	ESCUDO REPUBLIKI ZIELONEGO PRZYŁĄDKA documentation
enumeration	DJF	KORONA CZESKA documentation
enumeration	DKK	FRANK DŹIBUTI documentation

enumeration	DOP	KORONA DUŃSKA documentation
enumeration	DZD	PESO DOMINIKAŃSKIE documentation
enumeration	EGP	DINAR ALGIERSKI documentation
enumeration	ERN	FUNT EGIPSKI documentation
enumeration	ETB	NAKFA documentation
enumeration	EUR	BIRR documentation
enumeration	FJD	EURO documentation
enumeration	FKP	DOLAR FIDŹI documentation
enumeration	GBP	FUNT FALKLANDZKI documentation
enumeration	GEL	FUNT SZTERLING documentation
enumeration	GGP	LARI documentation
enumeration	GHS	FUNT GUERNSEY documentation
enumeration	GIP	GHANA CEDI documentation
enumeration	GMD	FUNT GIBALTARSKI documentation
enumeration	GNF	DALASI documentation
enumeration	GTQ	FRANK GWINEJSKI documentation
enumeration	GYP	QUETZAL documentation
enumeration	HKD	DOLAR GUJAŃSKI documentation
enumeration	HNL	DOLAR HONGKONGU documentation
enumeration	HRK	LEMPIRA documentation
enumeration	HTG	KUNA documentation
enumeration	HUF	GOURDE documentation
enumeration	IDR	FORINT documentation
enumeration	ILS	RUPIA INDONEZYJSKA documentation
enumeration	IMP	SZEKEL documentation
enumeration	INR	FUNT MANX documentation
enumeration	IQD	RUPIA INDYJSKA documentation
enumeration	IRR	DINAR IRACKI documentation
enumeration	ISK	RIAL IRAŃSKI documentation
enumeration	JEP	KORONA ISLANDZKA documentation

	enumeration	JMD	FUNT JERSEY documentation
	enumeration	JOD	DOLAR JAMAJSKI documentation
	enumeration	JPY	DINAR JORDAŃSKI documentation
	enumeration	KES	JEN documentation
	enumeration	KGS	SZYLING KENIJSKI documentation
	enumeration	KHR	SOM documentation
	enumeration	KMF	RIEL documentation
	enumeration	KPW	FRANK KOMORÓW documentation
	enumeration	KRW	WON PÓŁNOCNO-KOREAŃSKI documentation
	enumeration	KWD	WON POŁUDNIOWO-KOREAŃSKI documentation
	enumeration	KYD	DINAR KUWEJCKI documentation
	enumeration	KZT	DOLAR KAJMAŃSKI documentation
	enumeration	LAK	TENGE documentation
	enumeration	LBP	KIP documentation
	enumeration	LKR	FUNT LIBAŃSKI documentation
	enumeration	LRD	RUPIA LANKIJSKA documentation
	enumeration	LSL	DOLAR LIBERYJSKI documentation
	enumeration	LYD	LOTI documentation
	enumeration	MAD	DINAR LIBIJSKI documentation
	enumeration	MDL	DIRHAM MAROKAŃSKI documentation
	enumeration	MGA	LEJ MOŁDAWII documentation
	enumeration	MKD	ARIARY documentation
	enumeration	MMK	DENAR documentation
	enumeration	MNT	KYAT documentation
	enumeration	MOP	TUGRIK documentation
	enumeration	MRU	PATACA documentation
	enumeration	MUR	OUGUIYA documentation
	enumeration	MVR	RUPIA MAURITIUSU documentation
	enumeration	MWK	RUPIA MALEDIWSKA documentation
	enumeration	MXN	KWACHA MALAWIJSKA documentation

		PESO MEKSYKAŃSKIE
enumeration	MYR	documentation RINGGIT
enumeration	MZN	documentation METICAL
enumeration	NAD	documentation DOLAR NAMIBIJSKI
enumeration	NGN	documentation NAIRA
enumeration	NIO	documentation CORDOBA ORO
enumeration	NOK	documentation KORONA NORWESKA
enumeration	NPR	documentation RUPIA NEPAŁSKA
enumeration	NZD	documentation DOLAR NOWOZELANDZKI
enumeration	OMR	documentation RIAL OMAŃSKI
enumeration	PAB	documentation BALBOA
enumeration	PEN	documentation SOL
enumeration	PGK	documentation KINA
enumeration	PHP	documentation PESO FILIPIŃSKIE
enumeration	PKR	documentation RUPIA PAKISTAŃSKA
enumeration	PLN	documentation ZŁOTY
enumeration	PYG	documentation GUARANI
enumeration	QAR	documentation RIAL KATARSKI
enumeration	RON	documentation LEJ RUMUŃSKI
enumeration	RSD	documentation DINAR SERBSKI
enumeration	RUB	documentation RUBEL ROSYJSKI
enumeration	RWF	documentation FRANK RWANDYJSKI
enumeration	SAR	documentation RIAL SAUDYJSKI
enumeration	SBD	documentation DOLAR WYSP SALOMONA
enumeration	SCR	documentation RUPIA SESZELSKA
enumeration	SDG	documentation FUNT SUDAŃSKI
enumeration	SEK	documentation KORONA SZWEDZKA
enumeration	SGD	documentation DOLAR SINGAPURSKI
enumeration	SHP	documentation FUNT ŚWIĘTEJ HELENY (ŚWIĘTA HELENA I WYSPA WNIĘBOWSTĄPIENIA)
enumeration	SLL	documentation LEONE
enumeration	SOS	documentation

	enumeration	SRD	SZYLING SOMALIJSKI documentation
	enumeration	SSP	DOLAR SURINAMSKI documentation
	enumeration	STN	FUNT POŁUDNIOWOSUDAŃSKI documentation
	enumeration	SVC	DOBRA documentation
	enumeration	SYP	COLON SALWADORSKI (SV1) documentation
	enumeration	SZL	FUNT SYRYJSKI documentation
	enumeration	THB	LILANGENI documentation
	enumeration	TJS	BAT documentation
	enumeration	TMT	SOMONI documentation
	enumeration	TND	MANAT TURKMEŃSKI documentation
	enumeration	TOP	DINAR TUNEZYJSKI documentation
	enumeration	TRY	PAANGA documentation
	enumeration	TTD	LIRA TURECKA documentation
	enumeration	TWD	DDOLAR TRYNIDADU I TOBAGO documentation
	enumeration	TZS	NOWY DOLAR TAJWAŃSKI documentation
	enumeration	UAH	SZYLING TANZAŃSKI documentation
	enumeration	UGX	HRYWNA documentation
	enumeration	USD	SZYLING UGANDYJSKI documentation
	enumeration	UYU	DOLAR AMERYKAŃSKI documentation
	enumeration	UZS	PESO URUGWAJSKIE documentation
	enumeration	VES	SUM documentation
	enumeration	VND	BOLIWAR SOBERANO documentation
	enumeration	VUV	DONG documentation
	enumeration	WST	VATU documentation
	enumeration	XAF	TALA documentation
	enumeration	XCD	FRANK CFA (BEAC) documentation
	enumeration	XOF	DOLAR WSCHODNIO-KARAIBSKI documentation
	enumeration	XPF	FRANK CFA (BCEAO) documentation
	enumeration	YER	FRANK CFP documentation
	enumeration	ZAR	RIAL JEMEŃSKI documentation

	enumeration	ZMW	RAND documentation
	enumeration	ZWL	KWACHA ZAMBIJSKA documentation DOLAR ZIMBABWE
annotation	documentation Kod waluty transakcji płatniczych		

element **ITP/Podmiot2/AdresTerminala/Terminal/Transakcje/LiczbaTransakcji**

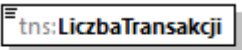
diagram	 <p>Liczba transakcji płatniczych zaakceptowanych przez akceptanta</p>		
namespace	http://itp.mf.gov.pl/wzor/2022/08/04/08042/		
type	<b>etd:TNaturalny</b>		
properties	content simple		
facets	Kind	Value	Annotation
	totalDigits	14	
	whiteSpace	collapse	
annotation	documentation Liczba transakcji płatniczych zaakceptowanych przez akceptanta		

element **ITP/Podmiot2/AdresTerminala/Terminal/Transakcje/WartoscTransakcji**

diagram	 <p>Wartość transakcji płatniczych zaakceptowanych przez akceptanta</p>		
namespace	http://itp.mf.gov.pl/wzor/2022/08/04/08042/		
type	<a href="#">tns:TKwotowy</a>		
properties	content simple		
facets	Kind	Value	Annotation
	totalDigits	18	
	fractionDigits	2	
annotation	documentation Wartość transakcji płatniczych zaakceptowanych przez akceptanta		

element **ITP/Pouczenia**

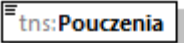
<p>diagram</p>	 <p>Pouczenia dla agenta. Wartość 1 oznacza potwierdzenie zapoznania się z treścią i akceptację poniższych pouczeń:</p> <ol style="list-style-type: none"> <li>1. Wypełnianie obowiązków, o których mowa w art. 278b, podlega kontroli wykonywanej przez Szefa Krajowej Administracji Skarbowej.</li> <li>2. Zgodnie z treścią przepisu art. 278e ustawy o zmianie niektórych ustaw w celu automatyzacji załatwiania niektórych spraw przez Krajową Administrację Skarbową agent rozliczeniowy, który nie dopełnia obowiązku przekazania Szefowi Krajowej Administracji Skarbowej w terminie określonym w art. 278b ust. 3 informacji, o której mowa w art. 278b ust. 1, przekazuje tę informację w niepełnym zakresie lub niezgodną z posiadanymi informacjami lub danymi lub niezgodnie z wymaganiami określonymi w art. 49aa ust. 4, podlega karze pieniężnej. Karę pieniężną nadaje Szef Krajowej Administracji Skarbowej w drodze decyzji. Od decyzji przysługuje wniosek o ponowne rozpatrzenie sprawy w ter...</li> </ol>																					
<p>namespace</p>	<p><a href="http://itp.mf.gov.pl/wzor/2022/08/04/08042/">http://itp.mf.gov.pl/wzor/2022/08/04/08042/</a></p>																					
<p>type</p>	<p>restriction of <b>etd:TKwota2Nieujemna</b></p>																					
<p>properties</p>	<p>content simple</p>																					
<p>facets</p>	<table border="1"> <thead> <tr> <th>Kind</th> <th>Value</th> <th>Annotation</th> </tr> </thead> <tbody> <tr> <td>minInclusive</td> <td>0</td> <td></td> </tr> <tr> <td>minExclusive</td> <td>0</td> <td></td> </tr> <tr> <td>maxExclusive</td> <td>2</td> <td></td> </tr> <tr> <td>totalDigits</td> <td>16</td> <td></td> </tr> <tr> <td>fractionDigits</td> <td>0</td> <td></td> </tr> <tr> <td>whiteSpace</td> <td>collapse</td> <td></td> </tr> </tbody> </table>	Kind	Value	Annotation	minInclusive	0		minExclusive	0		maxExclusive	2		totalDigits	16		fractionDigits	0		whiteSpace	collapse	
Kind	Value	Annotation																				
minInclusive	0																					
minExclusive	0																					
maxExclusive	2																					
totalDigits	16																					
fractionDigits	0																					
whiteSpace	collapse																					
<p>annotation</p>	<p>documentation Pouczenia dla agenta. Wartość 1 oznacza potwierdzenie zapoznania się z treścią i akceptację poniższych pouczeń:</p> <ol style="list-style-type: none"> <li>1. Wypełnianie obowiązków, o których mowa w art. 278b, podlega kontroli wykonywanej przez Szefa Krajowej Administracji Skarbowej.</li> <li>2. Zgodnie z treścią przepisu art. 278e ustawy o zmianie niektórych ustaw w celu automatyzacji załatwiania niektórych spraw przez Krajową Administrację Skarbową agent rozliczeniowy, który nie dopełnia obowiązku przekazania</li> </ol>																					

	<p>Szefowi Krajowej Administracji Skarbowej w terminie określonym w art. 278b ust. 3 informacji, o której mowa w art. 278b ust. 1, przekazuje tę informację w niepełnym zakresie lub niezgodną z posiadanymi informacjami lub danymi lub niezgodnie z wymaganiami określonymi w art. 49aa ust. 4, podlega karze pieniężnej. Karę pieniężną nadaje Szef Krajowej Administracji Skarbowej w drodze decyzji. Od decyzji przysługuje wniosek o ponowne rozpatrzenie sprawy w terminie 14 dni od dnia jej doręczenia.</p>
--	--

### complexType **TAdres**

diagram	
namespace	http://itp.mf.gov.pl/wzor/2022/08/04/08042/
children	<a href="#">tns:AdresPol</a> <a href="#">tns:AdresZagr</a>
used by	elements <a href="#">TOsobaNiefizyczna/AdresSiedziby</a> <a href="#">TPodmiotDowolny/AdresSiedziby</a> <a href="#">TOsobaNiefizyczna1/AdresSiedziby</a>
annotation	documentation Dane określające adres

### element **TAdres/AdresPol**

diagram	
namespace	http://itp.mf.gov.pl/wzor/2022/08/04/08042/
type	<a href="#">tns:TAdresPolskiITP</a>



properties	content complex
children	<a href="#">tns:KodKraju</a> <a href="#">tns:Wojewodztwo</a> <a href="#">tns:Ulica</a> <a href="#">tns:NrDomu</a> <a href="#">tns:NrLokalu</a> <a href="#">tns:Miejscowosc</a> <a href="#">tns:KodPocztowy</a>

element **TAdres/AdresZagr**

diagram	<pre> classDiagram     class tnsAdresZagr["tns:AdresZagr"]     class etdTAdresZagraniczny["etd:TAdresZagraniczny"]     class etdKodKraju["etd:KodKraju"]     class etdKodPocztowy["etd:KodPocztowy"]     class etdMiejscowosc["etd:Miejscowosc"]     class etdUlica["etd:Ulica"]     class etdNrDomu["etd:NrDomu"]     class etdNrLokalu["etd:NrLokalu"]      tnsAdresZagr -- etdTAdresZagraniczny     etdTAdresZagraniczny -- etdKodKraju     etdTAdresZagraniczny -- etdKodPocztowy     etdTAdresZagraniczny -- etdMiejscowosc     etdTAdresZagraniczny -- etdUlica     etdTAdresZagraniczny -- etdNrDomu     etdTAdresZagraniczny -- etdNrLokalu     </pre>
namespace	<a href="http://itp.mf.gov.pl/wzor/2022/08/04/08042/">http://itp.mf.gov.pl/wzor/2022/08/04/08042/</a>
type	<b>etd:TAdresZagraniczny</b>
properties	content complex
children	<b>etd:KodKraju</b> <b>etd:KodPocztowy</b> <b>etd:Miejscowosc</b> <b>etd:Ulica</b> <b>etd:NrDomu</b> <b>etd:NrLokalu</b>

complexType **TAdresPolskiITP**

diagram	
namespace	http://itp.mf.gov.pl/wzor/2022/08/04/08042/
children	<a href="#">tns:KodKraju</a> <a href="#">tns:Wojewodztwo</a> <a href="#">tns:Ulica</a> <a href="#">tns:NrDomu</a> <a href="#">tns:NrLokalu</a> <a href="#">tns:Miejscowosc</a> <a href="#">tns:KodPocztowy</a>
used by	elements <a href="#">TAdres/AdresPol</a> <a href="#">ITP/Podmiot2/AdresTerminala</a>
annotation	documentation Informacje opisujące adres polski - zakres danych dedykowany dla lokalizacji terminali

element **TAdresPolskiITP/KodKraju**

diagram																						
namespace	http://itp.mf.gov.pl/wzor/2022/08/04/08042/																					
type	<b>etd:TKodKraju</b>																					
properties	content simple fixed PL																					
facets	<table border="1"> <thead> <tr> <th>Kind</th> <th>Value</th> <th>Annotation</th> </tr> </thead> <tbody> <tr> <td>enumeration</td> <td>AF</td> <td>documentation AFGANISTAN</td> </tr> <tr> <td>enumeration</td> <td>AX</td> <td>documentation ALAND ISLANDS</td> </tr> <tr> <td>enumeration</td> <td>AL</td> <td>documentation ALBANIA</td> </tr> <tr> <td>enumeration</td> <td>DZ</td> <td>documentation ALGERIA</td> </tr> <tr> <td>enumeration</td> <td>AD</td> <td>documentation ANDORA</td> </tr> <tr> <td>enumeration</td> <td>AO</td> <td>documentation ANGOLA</td> </tr> </tbody> </table>	Kind	Value	Annotation	enumeration	AF	documentation AFGANISTAN	enumeration	AX	documentation ALAND ISLANDS	enumeration	AL	documentation ALBANIA	enumeration	DZ	documentation ALGERIA	enumeration	AD	documentation ANDORA	enumeration	AO	documentation ANGOLA
Kind	Value	Annotation																				
enumeration	AF	documentation AFGANISTAN																				
enumeration	AX	documentation ALAND ISLANDS																				
enumeration	AL	documentation ALBANIA																				
enumeration	DZ	documentation ALGERIA																				
enumeration	AD	documentation ANDORA																				
enumeration	AO	documentation ANGOLA																				

enumeration	AI	documentation ANGUILLA
enumeration	AQ	documentation ANTARKTYDA
enumeration	AG	documentation ANTIGUA I BARBUDA
enumeration	AN	documentation ANTYLE HOLENDERSKIE
enumeration	SA	documentation ARABIA SAUDYJSKA
enumeration	AR	documentation ARGENTYNA
enumeration	AM	documentation ARMENIA
enumeration	AW	documentation ARUBA
enumeration	AU	documentation AUSTRALIA
enumeration	AT	documentation AUSTRIA
enumeration	AZ	documentation AZERBEJDŻAN
enumeration	BS	documentation BAHAMY
enumeration	BH	documentation BAHRAJN
enumeration	BD	documentation BANGLADESZ
enumeration	BB	documentation BARBADOS
enumeration	BE	documentation BELGIA
enumeration	BZ	documentation BELIZE
enumeration	BJ	documentation BENIN
enumeration	BM	documentation BERMUDY
enumeration	BT	documentation BHUTAN
enumeration	BY	documentation BIAŁORUŚ
enumeration	BO	documentation BOLIWIA
enumeration	BQ	documentation BONAIRE, SINT EUSTATIUS I SABA
enumeration	BA	documentation BOŚNIA I HERCEGOWINA
enumeration	BW	documentation BOTSWANA
enumeration	BR	documentation BRAZYLIA
enumeration	BN	documentation BRUNEI DARUSSALAM
enumeration	IO	documentation BRYTYJSKIE TERYTORIUM OCEANU INDYJSKIEGO
enumeration	BG	documentation BUŁGARIA
enumeration	BF	documentation BURKINA FASO

enumeration	BI	documentation BURUNDI
enumeration	XC	documentation CEUTA
enumeration	CL	documentation CHILE
enumeration	CN	documentation CHINY
enumeration	HR	documentation CHORWACJA
enumeration	CW	documentation CURAÇAO
enumeration	CY	documentation CYPR
enumeration	TD	documentation CZAD
enumeration	ME	documentation CZARNOGÓRA
enumeration	DK	documentation DANIA
enumeration	DM	documentation DOMINIKA
enumeration	DO	documentation DOMINIKANA
enumeration	DJ	documentation DŻIBUTI
enumeration	EG	documentation EGIPT
enumeration	EC	documentation EKWADOR
enumeration	ER	documentation ERYTREA
enumeration	EE	documentation ESTONIA
enumeration	ET	documentation ETIOPIA
enumeration	FK	documentation FALKLANDY
enumeration	FJ	documentation FIDŻI REPUBLIKA
enumeration	PH	documentation FILIPINY
enumeration	FI	documentation FINLANDIA
enumeration	FR	documentation FRANCJA
enumeration	TF	documentation FRANCUSKIE TERYTORIUM POŁUDNIOWE
enumeration	GA	documentation GABON
enumeration	GM	documentation GAMBIA
enumeration	GH	documentation GHANA
enumeration	GI	documentation GIBRALTAR
enumeration	GR	documentation GRECJA
enumeration	GD	documentation GRENADA

enumeration	GL	documentation GRENLANDIA
enumeration	GE	documentation GRUZJA
enumeration	GU	documentation GUAM
enumeration	GG	documentation GUERNSEY
enumeration	GY	documentation GUJANA
enumeration	GF	documentation GUJANA FRANCUSKA
enumeration	GP	documentation GWADELUPA
enumeration	GT	documentation GWATEMALA
enumeration	GN	documentation GWINEA
enumeration	GQ	documentation GWINEA RÓWNIKOWA
enumeration	GW	documentation GWINEA-BISSAU
enumeration	HT	documentation HAITI
enumeration	ES	documentation HISZPANIA
enumeration	HN	documentation HONDURAS
enumeration	HK	documentation HONGKONG
enumeration	IN	documentation INDIE
enumeration	ID	documentation INDONEZJA
enumeration	IQ	documentation IRAK
enumeration	IR	documentation IRAN
enumeration	IE	documentation IRLANDIA
enumeration	IS	documentation ISLANDIA
enumeration	IL	documentation IZRAEL
enumeration	JM	documentation JAMAJKA
enumeration	JP	documentation JAPONIA
enumeration	YE	documentation JEMEN
enumeration	JE	documentation JERSEY
enumeration	JO	documentation JORDANIA
enumeration	KY	documentation KAJMANY
enumeration	KH	documentation KAMBODŻA
enumeration	CM	documentation KAMERUN

enumeration	CA	documentation KANADA
enumeration	QA	documentation KATAR
enumeration	KZ	documentation KAZACHSTAN
enumeration	KE	documentation KENIA
enumeration	KG	documentation KIRGISTAN
enumeration	KI	documentation KIRIBATI
enumeration	CO	documentation KOLUMBIA
enumeration	KM	documentation KOMORY
enumeration	CG	documentation KONGO
enumeration	CD	documentation KONGO, REPUBLIKA DEMOKRATYCZNA
enumeration	KP	documentation KOREAŃSKA REPUBLIKA LUDOWO-DEMOKRATYCZNA
enumeration	XK	documentation KOSOWO
enumeration	CR	documentation KOSTARYKA
enumeration	CU	documentation KUBA
enumeration	KW	documentation KUWEJT
enumeration	LA	documentation LAOS
enumeration	LS	documentation LESOTHO
enumeration	LB	documentation LIBAN
enumeration	LR	documentation LIBERIA
enumeration	LY	documentation LIBIA
enumeration	LI	documentation LIECHTENSTEIN
enumeration	LT	documentation LITWA
enumeration	LV	documentation ŁOTWA
enumeration	LU	documentation LUKSEMBURG
enumeration	MK	documentation MACEDONIA
enumeration	MG	documentation MADAGASKAR
enumeration	YT	documentation MAJOTTA
enumeration	MO	documentation MAKAU
enumeration	MW	documentation MALAWI
enumeration	MV	documentation MALEDIWY

enumeration	MY	documentation MALEZJA
enumeration	ML	documentation MALI
enumeration	MT	documentation MALTA
enumeration	MP	documentation MARIANY PÓLNOCNE
enumeration	MA	documentation MAROKO
enumeration	MQ	documentation MARTYNIKA
enumeration	MR	documentation MAURETANIA
enumeration	MU	documentation MAURITIUS
enumeration	MX	documentation MEKSYK
enumeration	XL	documentation MELILLA
enumeration	FM	documentation MIKRONEZJA
enumeration	UM	documentation MINOR
enumeration	MD	documentation MOŁDOWA
enumeration	MC	documentation MONAKO
enumeration	MN	documentation MONGOLIA
enumeration	MS	documentation MONTSERRAT
enumeration	MZ	documentation MOZAMBIK
enumeration	MM	documentation MYANMAR (BURMA)
enumeration	NA	documentation NAMIBIA
enumeration	NR	documentation NAURU
enumeration	NP	documentation NEPAL
enumeration	NL	documentation NIDERLANDY (HOLANDIA)
enumeration	DE	documentation NIEMCY
enumeration	NE	documentation NIGER
enumeration	NG	documentation NIGERIA
enumeration	NI	documentation NIKARAGUA
enumeration	NU	documentation NIUE
enumeration	NF	documentation NORFOLK
enumeration	NO	documentation NORWEGIA
enumeration	NC	documentation NOWA KALEDONIA

enumeration	NZ	documentation NOWA ZELANDIA
enumeration	PS	documentation OKUPOWANE TERYTORIUM PALESTYNY
enumeration	OM	documentation OMAN
enumeration	PK	documentation PAKISTAN
enumeration	PW	documentation PALAU
enumeration	PA	documentation PANAMA
enumeration	PG	documentation PAPUA NOWA GWINEA
enumeration	PY	documentation PARAGWAJ
enumeration	PE	documentation PERU
enumeration	PN	documentation PITCAIRN
enumeration	PF	documentation POLINEZJA FRANCUSKA
enumeration	PL	documentation POLSKA
enumeration	GS	documentation POŁUDNIOWA GEORGIA I POŁUD.WYSPY SANDWICH
enumeration	PT	documentation PORTUGALIA
enumeration	PR	documentation PORTORYKO
enumeration	CF	documentation REP.ŚRODKOWOAFRYKAŃSKA
enumeration	CZ	documentation REPUBLIKA CZESKA
enumeration	KR	documentation REPUBLIKA KOREI
enumeration	ZA	documentation REPUBLIKA POŁUDNIOWEJ AFRYKI
enumeration	RE	documentation REUNION
enumeration	RU	documentation ROSJA
enumeration	RO	documentation RUMUNIA
enumeration	RW	documentation RWANDA
enumeration	EH	documentation SAHARA ZACHODNIA
enumeration	BL	documentation SAINT BARTHELEMY
enumeration	KN	documentation SAINT KITTS I NEVIS
enumeration	LC	documentation SAINT LUCIA
enumeration	MF	documentation SAINT MARTIN
enumeration	VC	documentation SAINT VINCENT I GRENADYNY
enumeration	SV	documentation SALWADOR



enumeration	WS	documentation SAMOA
enumeration	AS	documentation SAMOA AMERYKAŃSKIE
enumeration	SM	documentation SAN MARINO
enumeration	SN	documentation SENEGAL
enumeration	RS	documentation SERBIA
enumeration	SC	documentation SESZELE
enumeration	SL	documentation SIERRA LEONE
enumeration	SG	documentation SINGAPUR
enumeration	SK	documentation SŁOWACJA
enumeration	SI	documentation SŁOWENIA
enumeration	SO	documentation SOMALIA
enumeration	LK	documentation SRI LANKA
enumeration	PM	documentation SAINT PIERRE I MIQUELON
enumeration	US	documentation STANY ZJEDNOCZONE AMERYKI
enumeration	SZ	documentation SUAZI
enumeration	SD	documentation SUDAN
enumeration	SS	documentation SUDAN POŁUDNIOWY
enumeration	SR	documentation SURINAM
enumeration	SJ	documentation SVALBARD I JAN MAYEN
enumeration	SH	documentation ŚWIĘTA HELENA
enumeration	SY	documentation SYRIA
enumeration	CH	documentation SZWAJCARIA
enumeration	SE	documentation SZWECJA
enumeration	TJ	documentation TADŻYKISTAN
enumeration	TH	documentation TAJLANDIA
enumeration	TW	documentation TAJWAN
enumeration	TZ	documentation TANZANIA
enumeration	TG	documentation TOGO
enumeration	TK	documentation TOKELAU
enumeration	TO	documentation TONGA

enumeration	TT	documentation TRYNIDAD I TOBAGO
enumeration	TN	documentation TUNEZJA
enumeration	TR	documentation TURCJA
enumeration	TM	documentation TURKMENISTAN
enumeration	TV	documentation TUVALU
enumeration	UG	documentation UGANDA
enumeration	UA	documentation UKRAINA
enumeration	UY	documentation URUGWAJ
enumeration	UZ	documentation UZBEKISTAN
enumeration	VU	documentation VANUATU
enumeration	WF	documentation WALLIS I FUTUNA
enumeration	VA	documentation WATYKAN
enumeration	HU	documentation WĘGRY
enumeration	VE	documentation WENEZUELA
enumeration	GB	documentation WIELKA BRYTANIA
enumeration	VN	documentation WIETNAM
enumeration	IT	documentation WŁOCHY
enumeration	TL	documentation WSCHODNI TIMOR
enumeration	CI	documentation WYBRZEŻE KOŚCI SŁONIOWEJ
enumeration	BV	documentation WYSPA BOUVETA
enumeration	CX	documentation WYSPA BOŻEGO NARODZENIA
enumeration	IM	documentation WYSPA MAN
enumeration	SX	documentation WYSPA SINT MAARTEN (CZĘŚĆ HOLENDERSKA WYSPY)
enumeration	CK	documentation WYSPY COOKA
enumeration	VI	documentation WYSPY DZIEWICZE-USA
enumeration	VG	documentation WYSPY DZIEWICZE-W.B.
enumeration	HM	documentation WYSPY HEARD I MCDONALD
enumeration	CC	documentation WYSPY KOKOSOWE (KEELINGA)
enumeration	MH	documentation WYSPY MARSHALLA
enumeration	FO	documentation WYSPY OWCZE

	enumeration	SB	documentation WYSPY SALOMONA
	enumeration	ST	documentation WYSPY ŚWIĘTEGO TOMASZA I KSIĄŻĘCA
	enumeration	TC	documentation WYSPY TURKS I CAICOS
	enumeration	ZM	documentation ZAMBIA
	enumeration	CV	documentation ZIELONY PRZYŁĄDEK
	enumeration	ZW	documentation ZIMBABWE
	enumeration	AE	documentation ZJEDNOCZONE EMIRATY ARABSKIE
	enumeration	XI	documentation ZJEDNOCZONE KRÓLESTWO (IRLANDIA PÓŁNOCNA)
annotation	documentation		Kraj

#### element **TAdresPolskiITP/Wojewodztwo**

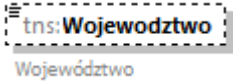
diagram			
namespace	http://itp.mf.gov.pl/wzor/2022/08/04/08042/		
type	<b>etd:TJednAdmin</b>		
properties	minOcc	0	
	maxOcc	1	
	content	simple	
facets	Kind	Value	Annotation
	minLength	1	
	maxLength	36	
annotation	documentation		Wojewodztwo

#### element **TAdresPolskiITP/Ulica**

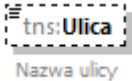
diagram			
namespace	http://itp.mf.gov.pl/wzor/2022/08/04/08042/		
type	<b>etd:TUlica</b>		
properties	minOcc	0	
	maxOcc	1	
	content	simple	
facets	Kind	Value	Annotation
	minLength	1	
	maxLength	65	
annotation	documentation		Nazwa ulicy

element **TAdresPolskiITP/NrDomu**

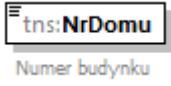
diagram	 Numer budynku									
namespace	http://itp.mf.gov.pl/wzor/2022/08/04/08042/									
type	<b>etd:TNrBudynku</b>									
properties	content simple									
facets	<table border="1"> <thead> <tr> <th>Kind</th> <th>Value</th> <th>Annotation</th> </tr> </thead> <tbody> <tr> <td>minLength</td> <td>1</td> <td></td> </tr> <tr> <td>maxLength</td> <td>9</td> <td></td> </tr> </tbody> </table>	Kind	Value	Annotation	minLength	1		maxLength	9	
Kind	Value	Annotation								
minLength	1									
maxLength	9									
annotation	documentation Numer budynku									

element **TAdresPolskiITP/NrLokalu**

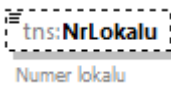
diagram	 Numer lokalu									
namespace	http://itp.mf.gov.pl/wzor/2022/08/04/08042/									
type	<b>etd:TNrLokalu</b>									
properties	<table border="1"> <tbody> <tr> <td>minOcc</td> <td>0</td> </tr> <tr> <td>maxOcc</td> <td>1</td> </tr> <tr> <td>content</td> <td>simple</td> </tr> </tbody> </table>	minOcc	0	maxOcc	1	content	simple			
minOcc	0									
maxOcc	1									
content	simple									
facets	<table border="1"> <thead> <tr> <th>Kind</th> <th>Value</th> <th>Annotation</th> </tr> </thead> <tbody> <tr> <td>minLength</td> <td>1</td> <td></td> </tr> <tr> <td>maxLength</td> <td>10</td> <td></td> </tr> </tbody> </table>	Kind	Value	Annotation	minLength	1		maxLength	10	
Kind	Value	Annotation								
minLength	1									
maxLength	10									
annotation	documentation Numer lokalu									

element **TAdresPolskiITP/Miejscowosc**

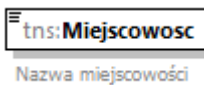
diagram	 Nazwa miejscowości									
namespace	http://itp.mf.gov.pl/wzor/2022/08/04/08042/									
type	<b>etd:TMiejscowosc</b>									
properties	content simple									
facets	<table border="1"> <thead> <tr> <th>Kind</th> <th>Value</th> <th>Annotation</th> </tr> </thead> <tbody> <tr> <td>minLength</td> <td>1</td> <td></td> </tr> <tr> <td>maxLength</td> <td>56</td> <td></td> </tr> </tbody> </table>	Kind	Value	Annotation	minLength	1		maxLength	56	
Kind	Value	Annotation								
minLength	1									
maxLength	56									
annotation	documentation Nazwa miejscowości									

element **TAdresPolskiITP/KodPocztowy**

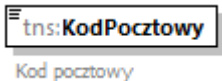
diagram	 Kod pocztowy												
namespace	http://itp.mf.gov.pl/wzor/2022/08/04/08042/												
type	<a href="#">tns:TKodPocztowyPL</a>												
properties	content simple												
facets	<table border="1"> <thead> <tr> <th>Kind</th> <th>Value</th> <th>Annotation</th> </tr> </thead> <tbody> <tr> <td>minLength</td> <td>1</td> <td></td> </tr> <tr> <td>maxLength</td> <td>8</td> <td></td> </tr> <tr> <td>pattern</td> <td>[0-9]{2}-[0-9]{3}</td> <td></td> </tr> </tbody> </table>	Kind	Value	Annotation	minLength	1		maxLength	8		pattern	[0-9]{2}-[0-9]{3}	
Kind	Value	Annotation											
minLength	1												
maxLength	8												
pattern	[0-9]{2}-[0-9]{3}												
annotation	documentation Kod pocztowy												

complexType **TIdentyfikatorOsobyFizycznej**

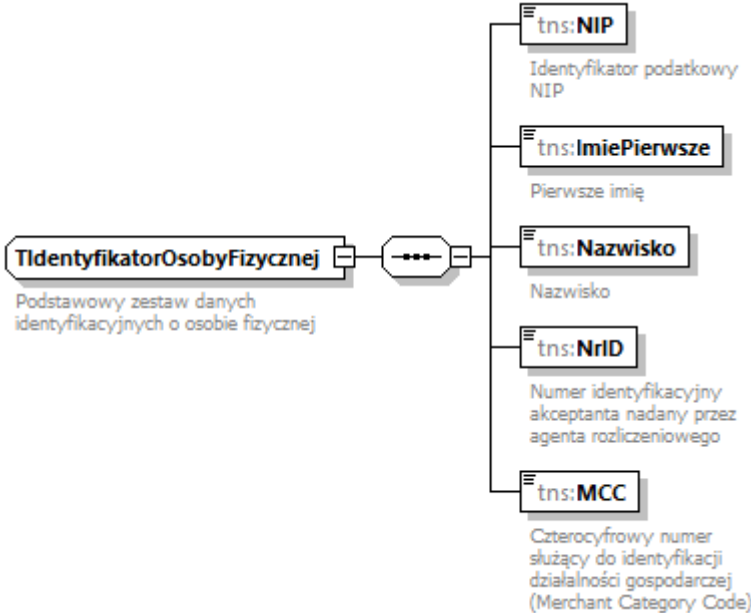
diagram	 Podstawowy zestaw danych identyfikacyjnych o osobie fizycznej
namespace	http://itp.mf.gov.pl/wzor/2022/08/04/08042/
children	<a href="#">tns:NIP</a> <a href="#">tns:ImiePierwsze</a> <a href="#">tns:Nazwisko</a> <a href="#">tns:NrID</a> <a href="#">tns:MCC</a>
used by	element <a href="#">TPodmiotDowolnyBezAdresu/OsobaFizyczna</a>
annotation	documentation Podstawowy zestaw danych identyfikacyjnych o osobie fizycznej

element **TIdentyfikatorOsobyFizycznej/NIP**

diagram	 Identyfikator podatkowy NIP
---------	--

namespace	http://itp.mf.gov.pl/wzor/2022/08/04/08042/						
type	<b>etd:TNrNIP</b>						
properties	content simple						
facets	<table border="1"> <thead> <tr> <th>Kind</th> <th>Value</th> <th>Annotation</th> </tr> </thead> <tbody> <tr> <td>pattern</td> <td>[1-9](\d[1-9])?(\d{1-7})?</td> <td></td> </tr> </tbody> </table>	Kind	Value	Annotation	pattern	[1-9](\d[1-9])?(\d{1-7})?	
Kind	Value	Annotation					
pattern	[1-9](\d[1-9])?(\d{1-7})?						
annotation	documentation Identyfikator podatkowy NIP						

#### element **TIdentyfikatorOsobyFizycznej/ImiePierwsze**

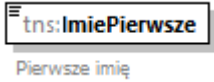
diagram										
namespace	http://itp.mf.gov.pl/wzor/2022/08/04/08042/									
type	<b>etd:TImie</b>									
properties	content simple									
facets	<table border="1"> <thead> <tr> <th>Kind</th> <th>Value</th> <th>Annotation</th> </tr> </thead> <tbody> <tr> <td>minLength</td> <td>1</td> <td></td> </tr> <tr> <td>maxLength</td> <td>30</td> <td></td> </tr> </tbody> </table>	Kind	Value	Annotation	minLength	1		maxLength	30	
Kind	Value	Annotation								
minLength	1									
maxLength	30									
annotation	documentation Pierwsze imię									

#### element **TIdentyfikatorOsobyFizycznej/Nazwisko**

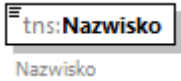
diagram										
namespace	http://itp.mf.gov.pl/wzor/2022/08/04/08042/									
type	<b>etd:TNazwisko</b>									
properties	content simple									
facets	<table border="1"> <thead> <tr> <th>Kind</th> <th>Value</th> <th>Annotation</th> </tr> </thead> <tbody> <tr> <td>minLength</td> <td>1</td> <td></td> </tr> <tr> <td>maxLength</td> <td>81</td> <td></td> </tr> </tbody> </table>	Kind	Value	Annotation	minLength	1		maxLength	81	
Kind	Value	Annotation								
minLength	1									
maxLength	81									
annotation	documentation Nazwisko									

#### element **TIdentyfikatorOsobyFizycznej/NrID**

diagram	
namespace	http://itp.mf.gov.pl/wzor/2022/08/04/08042/

type	restriction of <a href="#">tns:TZnakowyITP</a>									
properties	content simple									
facets	<table border="1"> <thead> <tr> <th>Kind</th> <th>Value</th> <th>Annotation</th> </tr> </thead> <tbody> <tr> <td>minLength</td> <td>1</td> <td></td> </tr> <tr> <td>maxLength</td> <td>15</td> <td></td> </tr> </tbody> </table>	Kind	Value	Annotation	minLength	1		maxLength	15	
Kind	Value	Annotation								
minLength	1									
maxLength	15									
annotation	documentation Numer identyfikacyjny akceptanta nadany przez agenta rozliczeniowego									

### element **TIdentyfikatorOsobyFizycznej/MCC**

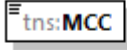
diagram	 <p>Czterocyfrowy numer służący do identyfikacji działalności gospodarczej (Merchant Category Code)</p>						
namespace	<a href="http://itp.mf.gov.pl/wzor/2022/08/04/08042/">http://itp.mf.gov.pl/wzor/2022/08/04/08042/</a>						
type	restriction of <b>xsd:string</b>						
properties	content simple						
facets	<table border="1"> <thead> <tr> <th>Kind</th> <th>Value</th> <th>Annotation</th> </tr> </thead> <tbody> <tr> <td>pattern</td> <td>\d{4}</td> <td></td> </tr> </tbody> </table>	Kind	Value	Annotation	pattern	\d{4}	
Kind	Value	Annotation					
pattern	\d{4}						
annotation	documentation Czterocyfrowy numer służący do identyfikacji działalności gospodarczej (Merchant Category Code)						

### complexType **TIdentyfikatorOsobyNiefizycznej**

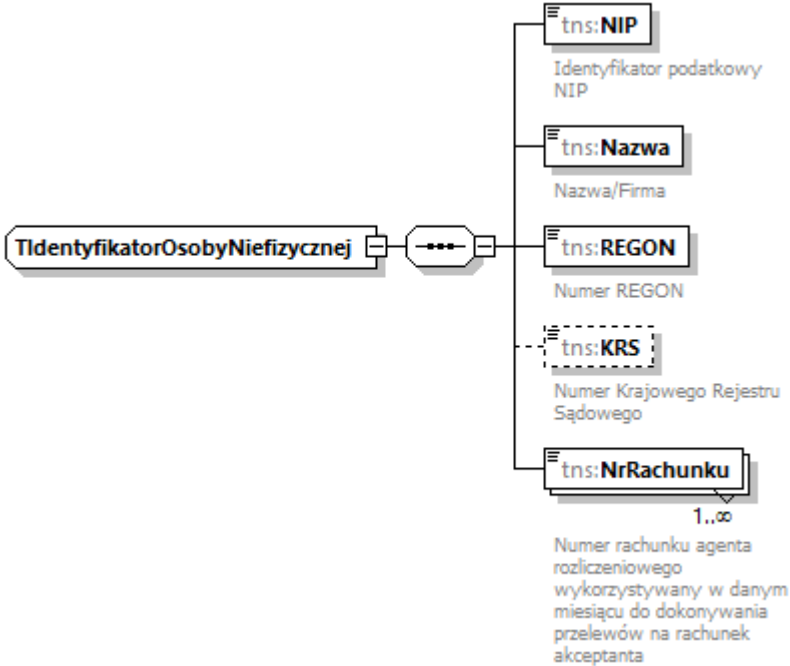
diagram	 <p>The diagram shows the structure of the <b>TIdentyfikatorOsobyNiefizycznej</b> complex type. It consists of several elements:</p> <ul style="list-style-type: none"> <li><b>tns:NIP</b>: Identyfikator podatkowy NIP</li> <li><b>tns:Nazwa</b>: Nazwa/Firma</li> <li><b>tns:REGON</b>: Numer REGON</li> <li><b>tns:KRS</b>: Numer Krajowego Rejestru Sądowego (shown as a dashed box, indicating it is optional)</li> <li><b>tns:NrRachunku</b>: Numer rachunku agenta rozliczeniowego wykorzystywany w danym miesiącu do dokonywania przelewów na rachunek akceptanta. Multiplicity: 1..∞</li> </ul>
namespace	<a href="http://itp.mf.gov.pl/wzor/2022/08/04/08042/">http://itp.mf.gov.pl/wzor/2022/08/04/08042/</a>

children	<a href="#">tns:NIP</a> <a href="#">tns:Nazwa</a> <a href="#">tns:REGON</a> <a href="#">tns:KRS</a> <a href="#">tns:NrRachunku</a>
used by	element <a href="#">TOsobaNiefizyczna/OsobaNiefizyczna</a>

element **TIdentyfikatorOsobyNiefizycznej/NIP**

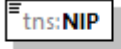
diagram	 Identyfikator podatkowy NIP						
namespace	<a href="http://itp.mf.gov.pl/wzor/2022/08/04/08042/">http://itp.mf.gov.pl/wzor/2022/08/04/08042/</a>						
type	<b>etd:TNrNIP</b>						
properties	content simple						
facets	<table border="1"> <thead> <tr> <th>Kind</th> <th>Value</th> <th>Annotation</th> </tr> </thead> <tbody> <tr> <td>pattern</td> <td>[1-9](\d[1-9])?(\d[1-9])?\d{7}</td> <td></td> </tr> </tbody> </table>	Kind	Value	Annotation	pattern	[1-9](\d[1-9])?(\d[1-9])?\d{7}	
Kind	Value	Annotation					
pattern	[1-9](\d[1-9])?(\d[1-9])?\d{7}						
annotation	documentation Identyfikator podatkowy NIP						

element **TIdentyfikatorOsobyNiefizycznej/Nazwa**

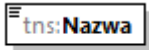
diagram	 Nazwa/Firma									
namespace	<a href="http://itp.mf.gov.pl/wzor/2022/08/04/08042/">http://itp.mf.gov.pl/wzor/2022/08/04/08042/</a>									
type	<b>etd:TZnakowy</b>									
properties	content simple									
facets	<table border="1"> <thead> <tr> <th>Kind</th> <th>Value</th> <th>Annotation</th> </tr> </thead> <tbody> <tr> <td>minLength</td> <td>1</td> <td></td> </tr> <tr> <td>maxLength</td> <td>240</td> <td></td> </tr> </tbody> </table>	Kind	Value	Annotation	minLength	1		maxLength	240	
Kind	Value	Annotation								
minLength	1									
maxLength	240									
annotation	documentation Nazwa/Firma									

element **TIdentyfikatorOsobyNiefizycznej/REGON**

diagram	 Numer REGON
namespace	<a href="http://itp.mf.gov.pl/wzor/2022/08/04/08042/">http://itp.mf.gov.pl/wzor/2022/08/04/08042/</a>
type	<b>etd:TNrREGON</b>
properties	content simple
annotation	documentation Numer REGON

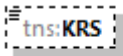

element **TIdentyfikatorOsobyNiefizycznej/KRS**

diagram	 <p>Numer Krajowego Rejestru Sądowego</p>
namespace	http://itp.mf.gov.pl/wzor/2022/08/04/08042/
type	<b>etd:TNRKRS</b>
properties	minOcc 0 maxOcc 1 content simple
facets	Kind Value Annotation pattern \d{10}
annotation	documentation Numer Krajowego Rejestru Sądowego

element **TIdentyfikatorOsobyNiefizycznej/NrRachunku**

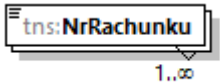
diagram	 <p>Numer rachunku agenta rozliczeniowego wykorzystywany w danym miesiącu do dokonywania przelewów na rachunek akceptanta</p>
namespace	http://itp.mf.gov.pl/wzor/2022/08/04/08042/
type	<a href="#">tns:TNRBITP</a>
properties	minOcc 1 maxOcc unbounded content simple
facets	Kind Value Annotation pattern [0-9A-Z]{10,32}
annotation	documentation Numer rachunku agenta rozliczeniowego wykorzystywany w danym miesiącu do dokonywania przelewów na rachunek akceptanta

complexType **TIdentyfikatorOsobyNiefizycznej1**

diagram	
namespace	http://itp.mf.gov.pl/wzor/2022/08/04/08042/
children	<a href="#">tns:NIP</a> <a href="#">tns:Nazwa</a> <a href="#">tns:NrID</a> <a href="#">tns:MCC</a>
used by	elements <a href="#">TPodmiotDowolnyBezAdresu/OsobaNiefizyczna</a> <a href="#">TOsobaNiefizyczna1/OsobaNiefizyczna</a>

element **TIdentyfikatorOsobyNiefizycznej1/NIP**

diagram							
namespace	http://itp.mf.gov.pl/wzor/2022/08/04/08042/						
type	<b>etd:TNRNIP</b>						
properties	content simple						
facets	<table border="1"> <thead> <tr> <th>Kind</th> <th>Value</th> <th>Annotation</th> </tr> </thead> <tbody> <tr> <td>pattern</td> <td>[1-9](\d[1-9])?(\d[1-9])?\d{7}</td> <td></td> </tr> </tbody> </table>	Kind	Value	Annotation	pattern	[1-9](\d[1-9])?(\d[1-9])?\d{7}	
Kind	Value	Annotation					
pattern	[1-9](\d[1-9])?(\d[1-9])?\d{7}						
annotation	documentation Identyfikator podatkowy NIP						

element **TIdentyfikatorOsobyNiefizycznej1/Nazwa**

diagram							
namespace	http://itp.mf.gov.pl/wzor/2022/08/04/08042/						
type	<b>etd:TZnakowy</b>						
properties	content simple						
facets	<table border="1"> <thead> <tr> <th>Kind</th> <th>Value</th> <th>Annotation</th> </tr> </thead> <tbody> <tr> <td>minLength</td> <td>1</td> <td></td> </tr> </tbody> </table>	Kind	Value	Annotation	minLength	1	
Kind	Value	Annotation					
minLength	1						

	maxLength 240
annotation	documentation Nazwa/Firma

element **TIdentyfikatorOsobyNiefizycznej1/NrID**

diagram	 <p>Numer identyfikacyjny akceptanta nadany przez agenta rozliczeniowego</p>									
namespace	http://itp.mf.gov.pl/wzor/2022/08/04/08042/									
type	restriction of <a href="#">tns:TZnakowyITP</a>									
properties	content simple									
facets	<table border="1"> <thead> <tr> <th>Kind</th> <th>Value</th> <th>Annotation</th> </tr> </thead> <tbody> <tr> <td>minLength</td> <td>1</td> <td></td> </tr> <tr> <td>maxLength</td> <td>15</td> <td></td> </tr> </tbody> </table>	Kind	Value	Annotation	minLength	1		maxLength	15	
Kind	Value	Annotation								
minLength	1									
maxLength	15									
annotation	documentation Numer identyfikacyjny akceptanta nadany przez agenta rozliczeniowego									

element **TIdentyfikatorOsobyNiefizycznej1/MCC**

diagram	 <p>Czterocyfrowy numer służący do identyfikacji działalności gospodarczej (Merchant Category Code)</p>						
namespace	http://itp.mf.gov.pl/wzor/2022/08/04/08042/						
type	restriction of <b>xsd:string</b>						
properties	content simple						
facets	<table border="1"> <thead> <tr> <th>Kind</th> <th>Value</th> <th>Annotation</th> </tr> </thead> <tbody> <tr> <td>pattern</td> <td>\d{4}</td> <td></td> </tr> </tbody> </table>	Kind	Value	Annotation	pattern	\d{4}	
Kind	Value	Annotation					
pattern	\d{4}						
annotation	documentation Czterocyfrowy numer służący do identyfikacji działalności gospodarczej (Merchant Category Code)						

### complexType TNaglowek

diagram	
namespace	http://itp.mf.gov.pl/wzor/2022/08/04/08042/
children	<a href="#">tns:KodFormularza</a> <a href="#">tns:WariantFormularza</a> <a href="#">tns:CelZlozenia</a> <a href="#">tns:DataWytworzenia</a> <a href="#">tns:KodUrzedu</a> <a href="#">tns:Rok</a> <a href="#">tns:Miesiac</a> <a href="#">tns:NIP</a>
used by	element <a href="#">ITP/Naglowek</a>

### element TNaglowek/KodFormularza

diagram																			
namespace	http://itp.mf.gov.pl/wzor/2022/08/04/08042/																		
type	extension of <a href="#">tns:TKodFormularza</a>																		
properties	content complex																		
facets	<table border="1"> <thead> <tr> <th>Kind</th> <th>Value</th> <th>Annotation</th> </tr> </thead> <tbody> <tr> <td>enumeration</td> <td>ITP</td> <td></td> </tr> </tbody> </table>	Kind	Value	Annotation	enumeration	ITP													
Kind	Value	Annotation																	
enumeration	ITP																		
attributes	<table border="1"> <thead> <tr> <th>Name</th> <th>Type</th> <th>Use</th> <th>Default</th> <th>Fixed</th> <th>Annotation</th> </tr> </thead> <tbody> <tr> <td><a href="#">kodSystemowy</a></td> <td><b>xsd:string</b></td> <td>required</td> <td></td> <td>ITP (1)</td> <td></td> </tr> <tr> <td><a href="#">wersjaSchemy</a></td> <td><b>xsd:string</b></td> <td>required</td> <td></td> <td>1-0</td> <td></td> </tr> </tbody> </table>	Name	Type	Use	Default	Fixed	Annotation	<a href="#">kodSystemowy</a>	<b>xsd:string</b>	required		ITP (1)		<a href="#">wersjaSchemy</a>	<b>xsd:string</b>	required		1-0	
Name	Type	Use	Default	Fixed	Annotation														
<a href="#">kodSystemowy</a>	<b>xsd:string</b>	required		ITP (1)															
<a href="#">wersjaSchemy</a>	<b>xsd:string</b>	required		1-0															

attribute **TNaglowek/KodFormularza/@kodSystemowy**

type	<b>xsd:string</b>
properties	use required fixed ITP (1)

attribute **TNaglowek/KodFormularza/@wersjaSchemy**

type	<b>xsd:string</b>
properties	use required fixed 1-0

element **TNaglowek/WariantFormularza**

diagram							
namespace	http://itp.mf.gov.pl/wzor/2022/08/04/08042/						
type	restriction of <b>xsd:byte</b>						
properties	content simple						
facets	<table border="1"> <thead> <tr> <th>Kind</th> <th>Value</th> <th>Annotation</th> </tr> </thead> <tbody> <tr> <td>enumeration</td> <td>1</td> <td></td> </tr> </tbody> </table>	Kind	Value	Annotation	enumeration	1	
Kind	Value	Annotation					
enumeration	1						

element **TNaglowek/CelZlozenia**

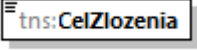
diagram										
namespace	http://itp.mf.gov.pl/wzor/2022/08/04/08042/									
type	<b>etd:TCelZlozenia</b>									
properties	content simple									
facets	<table border="1"> <thead> <tr> <th>Kind</th> <th>Value</th> <th>Annotation</th> </tr> </thead> <tbody> <tr> <td>enumeration</td> <td>1</td> <td>documentation złożenie po raz pierwszy deklaracji za dany okres</td> </tr> <tr> <td>enumeration</td> <td>2</td> <td>documentation korekta deklaracji za dany okres</td> </tr> </tbody> </table>	Kind	Value	Annotation	enumeration	1	documentation złożenie po raz pierwszy deklaracji za dany okres	enumeration	2	documentation korekta deklaracji za dany okres
Kind	Value	Annotation								
enumeration	1	documentation złożenie po raz pierwszy deklaracji za dany okres								
enumeration	2	documentation korekta deklaracji za dany okres								

element **TNaglowek/DataWytworzenia**

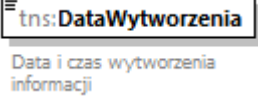
diagram	
namespace	http://itp.mf.gov.pl/wzor/2022/08/04/08042/
type	restriction of <b>etd:TDataCzas</b>
properties	content simple

facets	Kind	Value	Annotation
	minInclusive	2023-01-01T00:00:00Z	
	whiteSpace	collapse	
annotation	documentation Data i czas wytworzenia informacji		

#### element **TNaglowek/KodUrzedu**

diagram	 <p>Miejsce składania informacji - Szef KAS</p>		
namespace	http://itp.mf.gov.pl/wzor/2022/08/04/08042/		
type	restriction of <b>xsd:string</b>		
properties	content simple		
facets	Kind	Value	Annotation
	enumeration	0000	
annotation	documentation Miejsce składania informacji - Szef KAS		

#### element **TNaglowek/Rok**

diagram	 <p>Rok, którego dotyczy informacja</p>		
namespace	http://itp.mf.gov.pl/wzor/2022/08/04/08042/		
type	restriction of <b>etd:TRok</b>		
properties	content simple		
facets	Kind	Value	Annotation
	minInclusive	2022	
	maxInclusive	2050	
annotation	documentation Rok, którego dotyczy informacja		

#### element **TNaglowek/Miesiac**

diagram	 <p>Miesiąc, którego dotyczy informacja</p>		
namespace	http://itp.mf.gov.pl/wzor/2022/08/04/08042/		
type	<b>etd:TMiesiac</b>		
properties	content simple		
facets	Kind	Value	Annotation
	minInclusive	1	

	maxInclusive 12
annotation	documentation Miesiąc, którego dotyczy informacja

### element TNaglowek/NIP

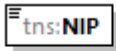
diagram	 Identyfikator podatkowy NIP agenta
namespace	http://itp.mf.gov.pl/wzor/2022/08/04/08042/
type	etd:TNrNIP
properties	content simple
facets	Kind Value Annotation pattern [1-9](\d[1-9])?(\d[1-9])\d{7}
annotation	documentation Identyfikator podatkowy NIP agenta

### complexType TOsobaNiefizyczna

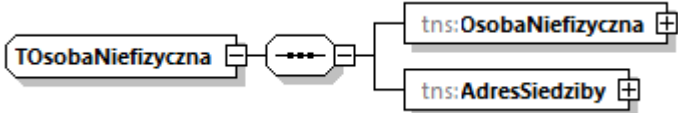
diagram	
namespace	http://itp.mf.gov.pl/wzor/2022/08/04/08042/
children	<a href="#">tns:OsobaNiefizyczna</a> <a href="#">tns:AdresSiedziby</a>
used by	element <a href="#">ITP/Podmiot1</a>

element **TOsobaNiefizyczna/OsobaNiefizyczna**

diagram	
namespace	<a href="http://itp.mf.gov.pl/wzor/2022/08/04/08042/">http://itp.mf.gov.pl/wzor/2022/08/04/08042/</a>
type	<a href="#">tns:TIdentyfikatorOsobyNiefizycznej</a>
properties	content complex
children	<a href="#">tns:NIP</a> <a href="#">tns:Nazwa</a> <a href="#">tns:REGON</a> <a href="#">tns:KRS</a> <a href="#">tns:NrRachunku</a>

element **TOsobaNiefizyczna/AdresSiedziby**

diagram	
namespace	<a href="http://itp.mf.gov.pl/wzor/2022/08/04/08042/">http://itp.mf.gov.pl/wzor/2022/08/04/08042/</a>
type	<a href="#">tns:TAdres</a>
properties	content complex
children	<a href="#">tns:AdresPol</a> <a href="#">tns:AdresZagr</a>



### complexType **TOsobaNiefizyczna1**

diagram	
namespace	http://itp.mf.gov.pl/wzor/2022/08/04/08042/
children	<a href="#">tns:OsobaNiefizyczna</a> <a href="#">tns:AdresSiedziby</a>

### element **TOsobaNiefizyczna1/OsobaNiefizyczna**

diagram	
namespace	http://itp.mf.gov.pl/wzor/2022/08/04/08042/
type	<a href="#">tns:TIdentyfikatorOsobyNiefizycznej1</a>
properties	content complex
children	<a href="#">tns:NIP</a> <a href="#">tns:Nazwa</a> <a href="#">tns:NrID</a> <a href="#">tns:MCC</a>

### element **TOsobaNiefizyczna1/AdresSiedziby**

diagram	
namespace	http://itp.mf.gov.pl/wzor/2022/08/04/08042/
type	<a href="#">tns:TAdres</a>

properties	content complex
children	<a href="#">tns:AdresPol</a> <a href="#">tns:AdresZagr</a>

### complexType **TPodmiotDowolny**

diagram	
namespace	<a href="http://itp.mf.gov.pl/wzor/2022/08/04/08042/">http://itp.mf.gov.pl/wzor/2022/08/04/08042/</a>
type	extension of <a href="#">tns:TPodmiotDowolnyBezAdresu</a>
properties	base <a href="#">tns:TPodmiotDowolnyBezAdresu</a>
children	<a href="#">tns:OsobaFizyczna</a> <a href="#">tns:OsobaNiefizyczna</a> <a href="#">tns:AdresSiedziby</a>
used by	element <a href="#">ITP/Podmiot2</a>
annotation	documentation Zestaw danych o osobie fizycznej lub niefizycznej

### element **TPodmiotDowolny/AdresSiedziby**

diagram	
namespace	<a href="http://itp.mf.gov.pl/wzor/2022/08/04/08042/">http://itp.mf.gov.pl/wzor/2022/08/04/08042/</a>
type	<a href="#">tns:TAdres</a>
properties	content complex
children	<a href="#">tns:AdresPol</a> <a href="#">tns:AdresZagr</a>

### complexType **TPodmiotDowolnyBezAdresu**

diagram	
namespace	<a href="http://itp.mf.gov.pl/wzor/2022/08/04/08042/">http://itp.mf.gov.pl/wzor/2022/08/04/08042/</a>

children	<a href="#">tns:OsobaFizyczna</a> <a href="#">tns:OsobaNiefizyczna</a>
used by	complexType <a href="#">TPodmiotDowolny</a>
annotation	documentation estaw danych o osobie fizycznej lub niefizycznej

element **TPodmiotDowolnyBezAdresu/OsobaFizyczna**

diagram	<pre> classDiagram     class tnsOsobaFizyczna["tns:OsobaFizyczna"]     class tnsNIP["tns:NIP"]     class tnsImiePierwsze["tns:ImiePierwsze"]     class tnsNazwisko["tns:Nazwisko"]     class tnsNrID["tns:NrID"]     class tnsMCC["tns:MCC"]     tnsOsobaFizyczna -- tnsNIP     tnsOsobaFizyczna -- tnsImiePierwsze     tnsOsobaFizyczna -- tnsNazwisko     tnsOsobaFizyczna -- tnsNrID     tnsOsobaFizyczna -- tnsMCC     </pre> <p>The diagram illustrates the structure of the <b>tns:OsobaFizyczna</b> complex type. It is composed of five elements, all of which are optional (indicated by the three horizontal lines on the top-left of each element box):</p> <ul style="list-style-type: none"> <li><b>tns:NIP</b>: Identyfikator podatkowy NIP</li> <li><b>tns:ImiePierwsze</b>: Pierwsze imię</li> <li><b>tns:Nazwisko</b>: Nazwisko</li> <li><b>tns:NrID</b>: Numer identyfikacyjny akceptanta nadany przez agenta rozliczeniowego</li> <li><b>tns:MCC</b>: Czterocyfrowy numer służący do identyfikacji działalności gospodarczej (Merchant Category Code)</li> </ul> <p>The elements are grouped under a dashed box labeled <b>tns:TIdentyfikatorOsobyFizycznej</b>.</p>
namespace	<a href="http://itp.mf.gov.pl/wzor/2022/08/04/08042/">http://itp.mf.gov.pl/wzor/2022/08/04/08042/</a>
type	<a href="#">tns:TIdentyfikatorOsobyFizycznej</a>
properties	content complex
children	<a href="#">tns:NIP</a> <a href="#">tns:ImiePierwsze</a> <a href="#">tns:Nazwisko</a> <a href="#">tns:NrID</a> <a href="#">tns:MCC</a>

element **TPodmiotDowolnyBezAdresu/OsobaNiefizyczna**

diagram	
namespace	<a href="http://itp.mf.gov.pl/wzor/2022/08/04/08042/">http://itp.mf.gov.pl/wzor/2022/08/04/08042/</a>
type	<a href="#">tns:TIdentyfikatorOsobyNiefizycznej1</a>
properties	content complex
children	<a href="#">tns:NIP</a> <a href="#">tns:Nazwa</a> <a href="#">tns:NrID</a> <a href="#">tns:MCC</a>

simpleType **TData**

namespace	<a href="http://itp.mf.gov.pl/wzor/2022/08/04/08042/">http://itp.mf.gov.pl/wzor/2022/08/04/08042/</a>												
type	restriction of <b>etd:TData</b>												
properties	base etd:TData												
used by	elements <a href="#">ITP/Podmiot2/AdresTerminala/Terminal/DataDo</a> <a href="#">ITP/Podmiot2/AdresTerminala/Terminal/DataOd</a>												
facets	<table border="1"> <thead> <tr> <th>Kind</th> <th>Value</th> <th>Annotation</th> </tr> </thead> <tbody> <tr> <td>minInclusive</td> <td>1990-01-01</td> <td></td> </tr> <tr> <td>maxInclusive</td> <td>2050-12-31</td> <td></td> </tr> <tr> <td>pattern</td> <td>((\d{4})-(\d{2})-(\d{2}))</td> <td></td> </tr> </tbody> </table>	Kind	Value	Annotation	minInclusive	1990-01-01		maxInclusive	2050-12-31		pattern	((\d{4})-(\d{2})-(\d{2}))	
Kind	Value	Annotation											
minInclusive	1990-01-01												
maxInclusive	2050-12-31												
pattern	((\d{4})-(\d{2})-(\d{2}))												
annotation	documentation Typ daty												

simpleType **TKodFormularza**

namespace	<a href="http://itp.mf.gov.pl/wzor/2022/08/04/08042/">http://itp.mf.gov.pl/wzor/2022/08/04/08042/</a>
type	restriction of <b>xsd:string</b>
properties	base xsd:string
used by	element <a href="#">TNaglowek/KodFormularza</a>

facets	Kind Value Annotation enumeration ITP
annotation	documentation Symbol wzoru formularza

### simpleType **TKodPocztowyPL**

namespace	<a href="http://itp.mf.gov.pl/wzor/2022/08/04/08042/">http://itp.mf.gov.pl/wzor/2022/08/04/08042/</a>
type	restriction of <b>etd:TKodPocztowy</b>
properties	base etd:TKodPocztowy
used by	element <a href="#">ITP/AdresPolskiITP/KodPocztowy</a>
facets	Kind Value Annotation minLength 1 maxLength 8 pattern [0-9]{2}-[0-9]{3}
annotation	documentation Kod pocztowy polski

### simpleType **TKwotowy**

namespace	<a href="http://itp.mf.gov.pl/wzor/2022/08/04/08042/">http://itp.mf.gov.pl/wzor/2022/08/04/08042/</a>
type	restriction of <b>xsd:decimal</b>
properties	base xsd:decimal
used by	element <a href="#">ITP/Podmiot2/AdresTerminala/Terminal/Transakcje/WartoscTransakcji</a>
facets	Kind Value Annotation totalDigits 18 fractionDigits 2
annotation	documentation Wartość numeryczna 18 znaków max, w tym 2 znaki po przecinku

### simpleType **TNrRBITP**

namespace	<a href="http://itp.mf.gov.pl/wzor/2022/08/04/08042/">http://itp.mf.gov.pl/wzor/2022/08/04/08042/</a>
type	restriction of <b>xsd:string</b>
properties	base xsd:string
used by	elements <a href="#">ITP/Podmiot2/AdresTerminala/Terminal/NrRachunku</a> <a href="#">TIdentyfikatorOsobyNiefizycznej/NrRachunku</a>
facets	Kind Value Annotation pattern [0-9A-Z]{10,32}
annotation	documentation Numer rachunku bankowego

### simpleType **TZnakowyITP**

namespace	<a href="http://itp.mf.gov.pl/wzor/2022/08/04/08042/">http://itp.mf.gov.pl/wzor/2022/08/04/08042/</a>
-----------	---

type	restriction of <b>xsd:token</b>									
properties	base <code>xsd:token</code>									
used by	elements <a href="#">TIdentyfikatorOsobyFizycznej/NrID</a> <a href="#">TIdentyfikatorOsobyNiefizycznej1/NrID</a> <a href="#">ITP/Podmiot2/AdresTerminala/Terminal/NrTerminala</a>									
facets	<table> <thead> <tr> <th>Kind</th> <th>Value</th> <th>Annotation</th> </tr> </thead> <tbody> <tr> <td>minLength</td> <td>1</td> <td></td> </tr> <tr> <td>maxLength</td> <td>256</td> <td></td> </tr> </tbody> </table>	Kind	Value	Annotation	minLength	1		maxLength	256	
Kind	Value	Annotation								
minLength	1									
maxLength	256									
annotation	documentation Typ znakowy ograniczony do 256 znaków									

XML Schema documentation generated by [XMLSpy](http://www.altova.com/xmlspy) Schema Editor <http://www.altova.com/xmlspy>