

COROLLA HYBRID

HATCHBACK / LHD

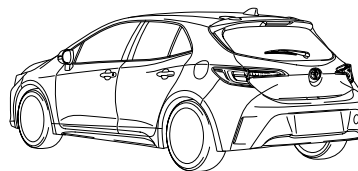







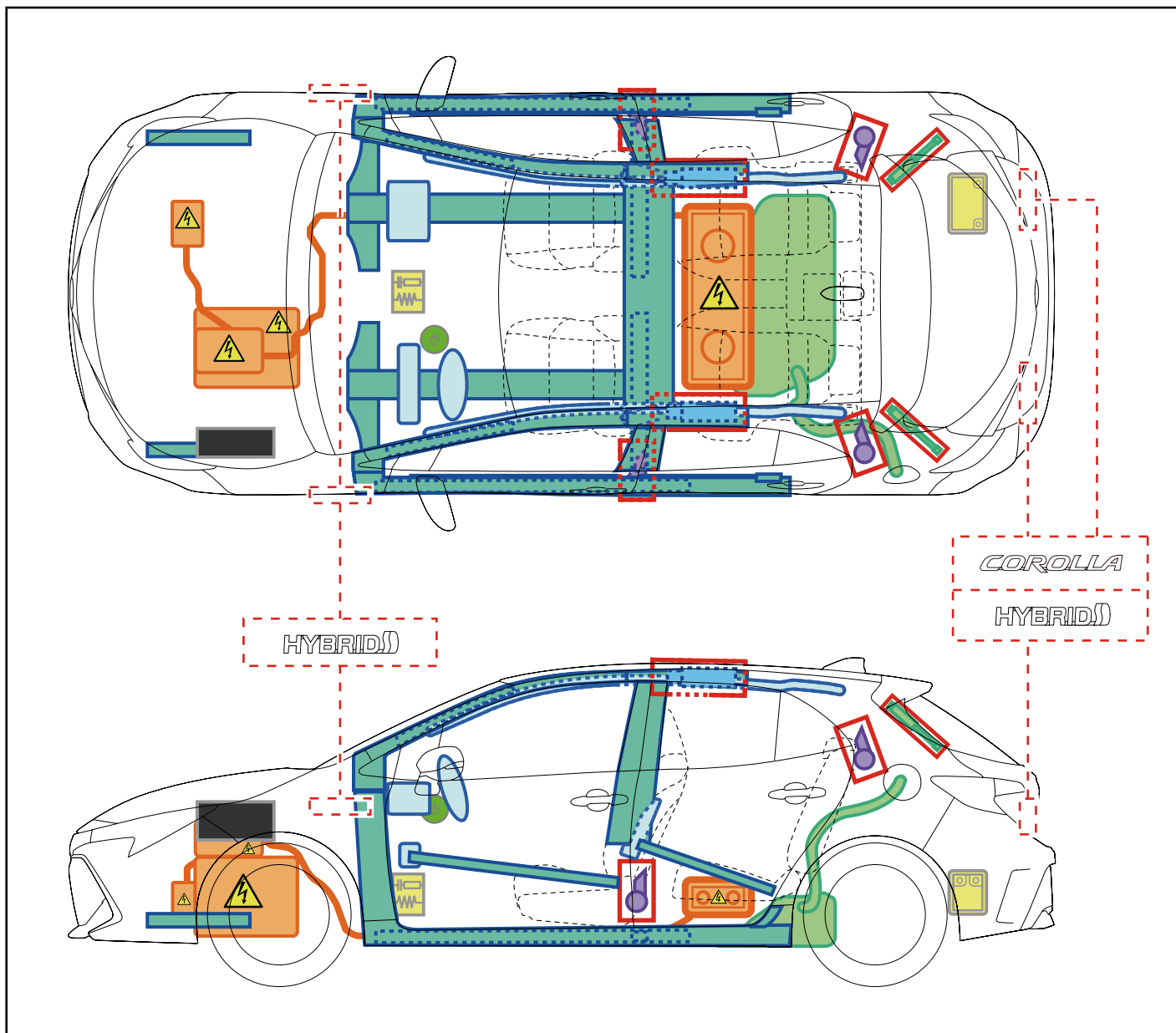



(MZEH1#)

2019-1



TOYOTA



	Wyłącznik zapłonu/ Przycisk rozruchu		Skrzynka bezpieczników		Akumulator 12V
	Poduszka powietrzna (w tym napełniacz)		Generator gazu		Akumulator wysokonapięciowy
	Obwód wysokiego napięcia		Zbiornik paliwa		Sprężyna gazowa
	Napinacz pasa bezpieczeństwa		Wzmocnienie nadwozia		Sterownik
-	-	-	-	-	-

Zabezpieczenie pojazdu

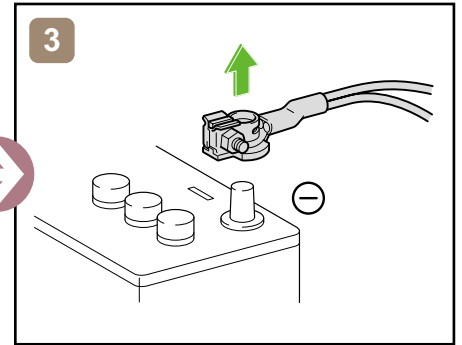
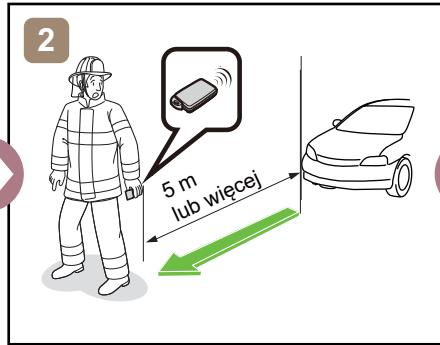
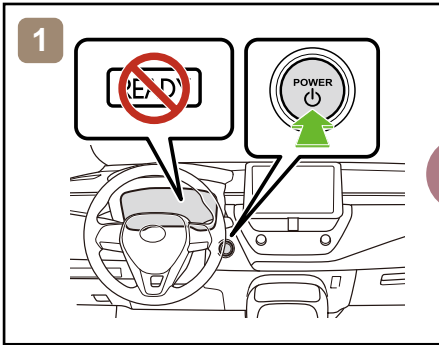

lub

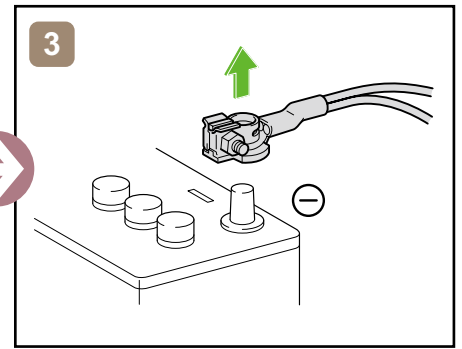
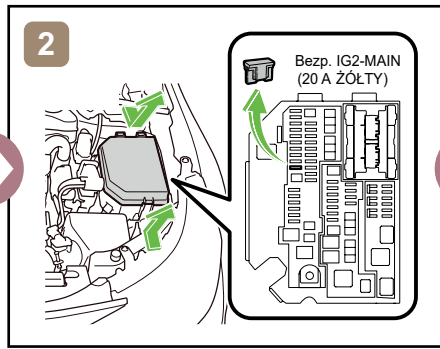
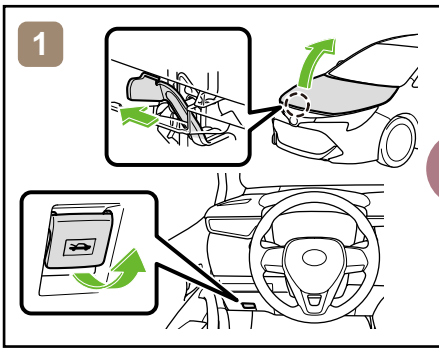

Dostęp do akumulatora 12V

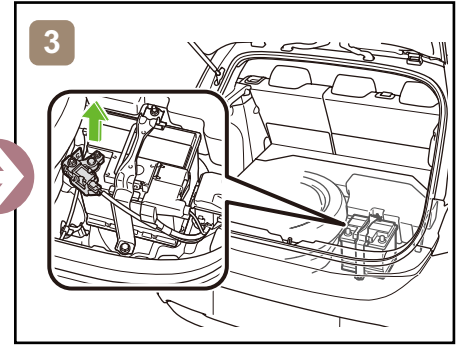
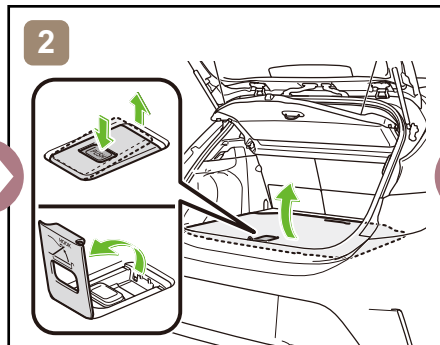
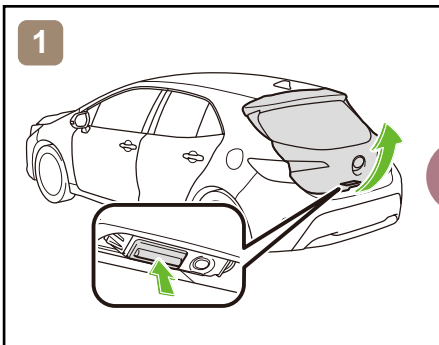

Holowanie pojazdu

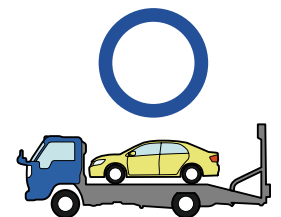
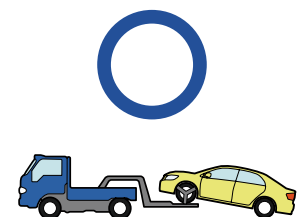
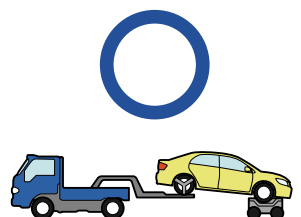
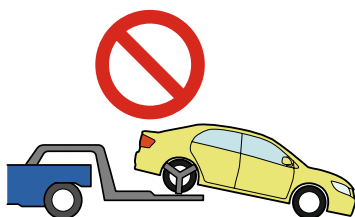







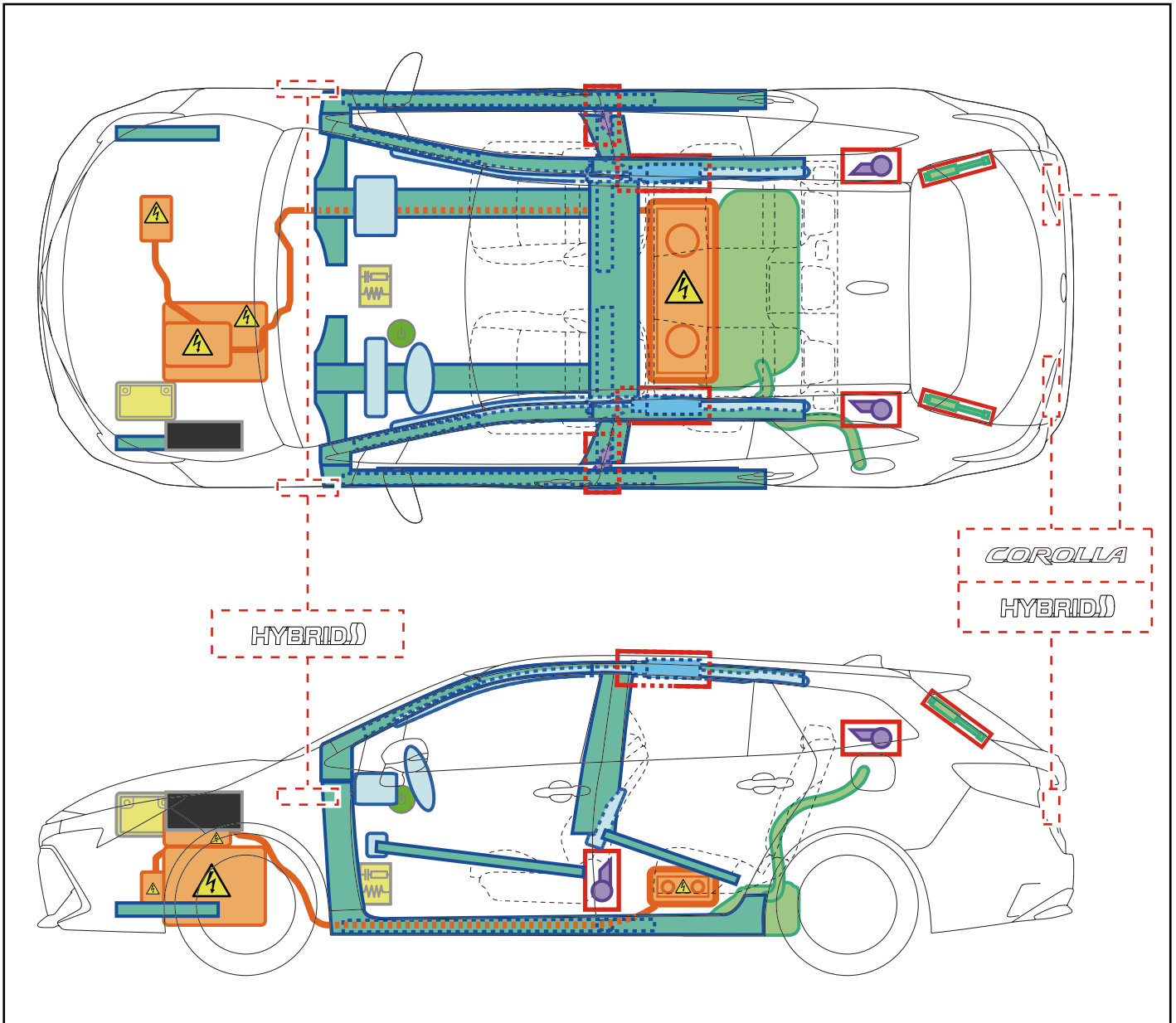
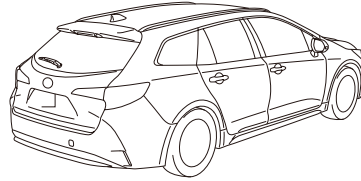
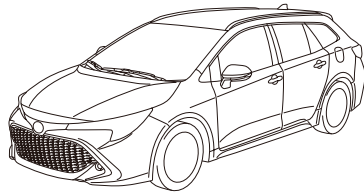





COROLLA HYBRID

WAGON / LHD
(ZWE21#)

2019-1



	Wyłącznik zapłonu/ Przycisk rozruchu		Skrzynka bezpieczników		Akumulator 12V
	Poduszka powietrzna (w tym napełniacz)		Generator gazu		Akumulator wysokonapięciowy
	Obwód wysokiego napięcia		Zbiornik paliwa		Sprężyna gazowa
	Napinacz pasa bezpieczeństwa		Wzmocnienia konstrukcji nadwozia		Sterownik
-	-	-	-	-	-

Zabezpieczenie pojazdu

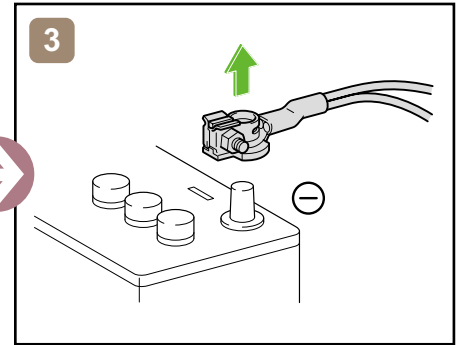
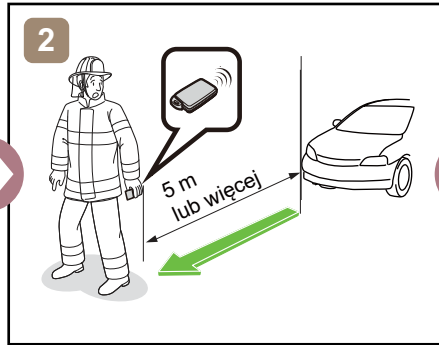
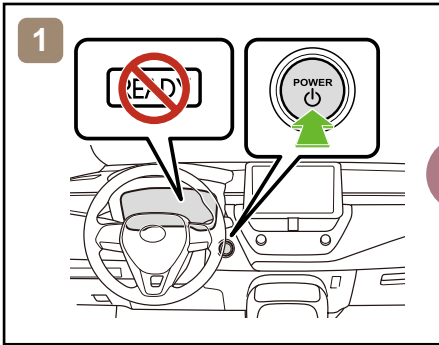

lub

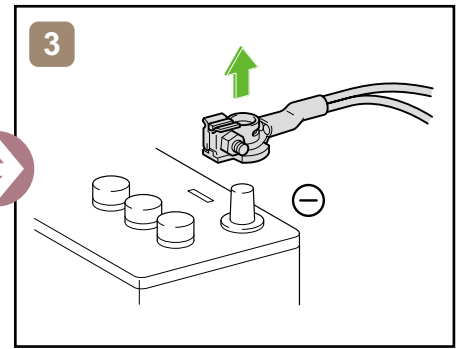
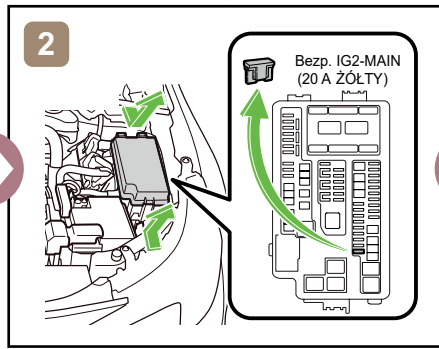
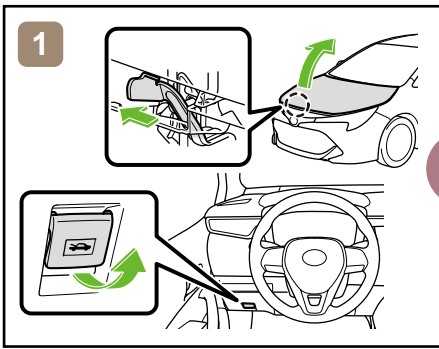

Dostęp do akumulatora 12V

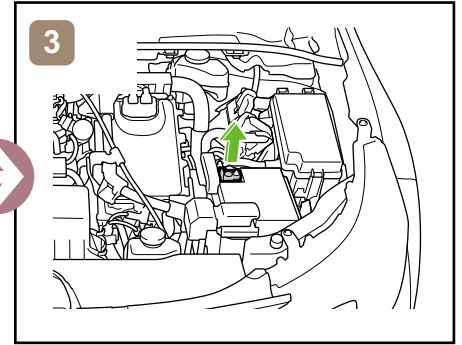
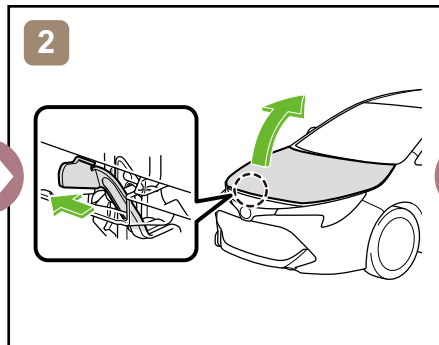
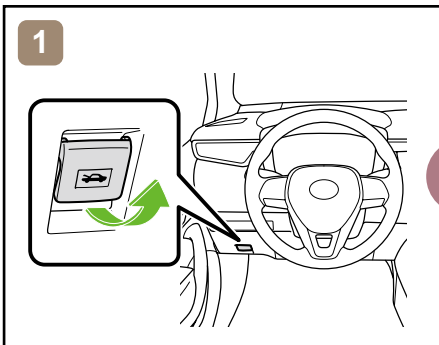

Holowanie pojazdu

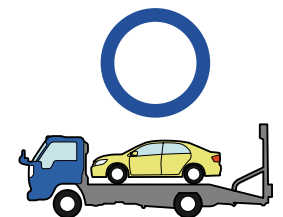
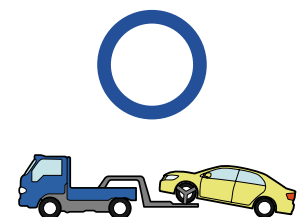
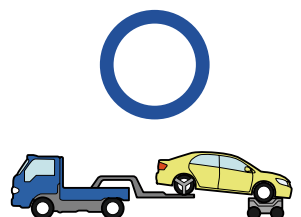

PRIUS

LHD

2015-11

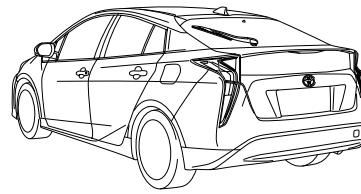
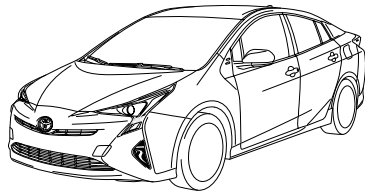

TOYOTA

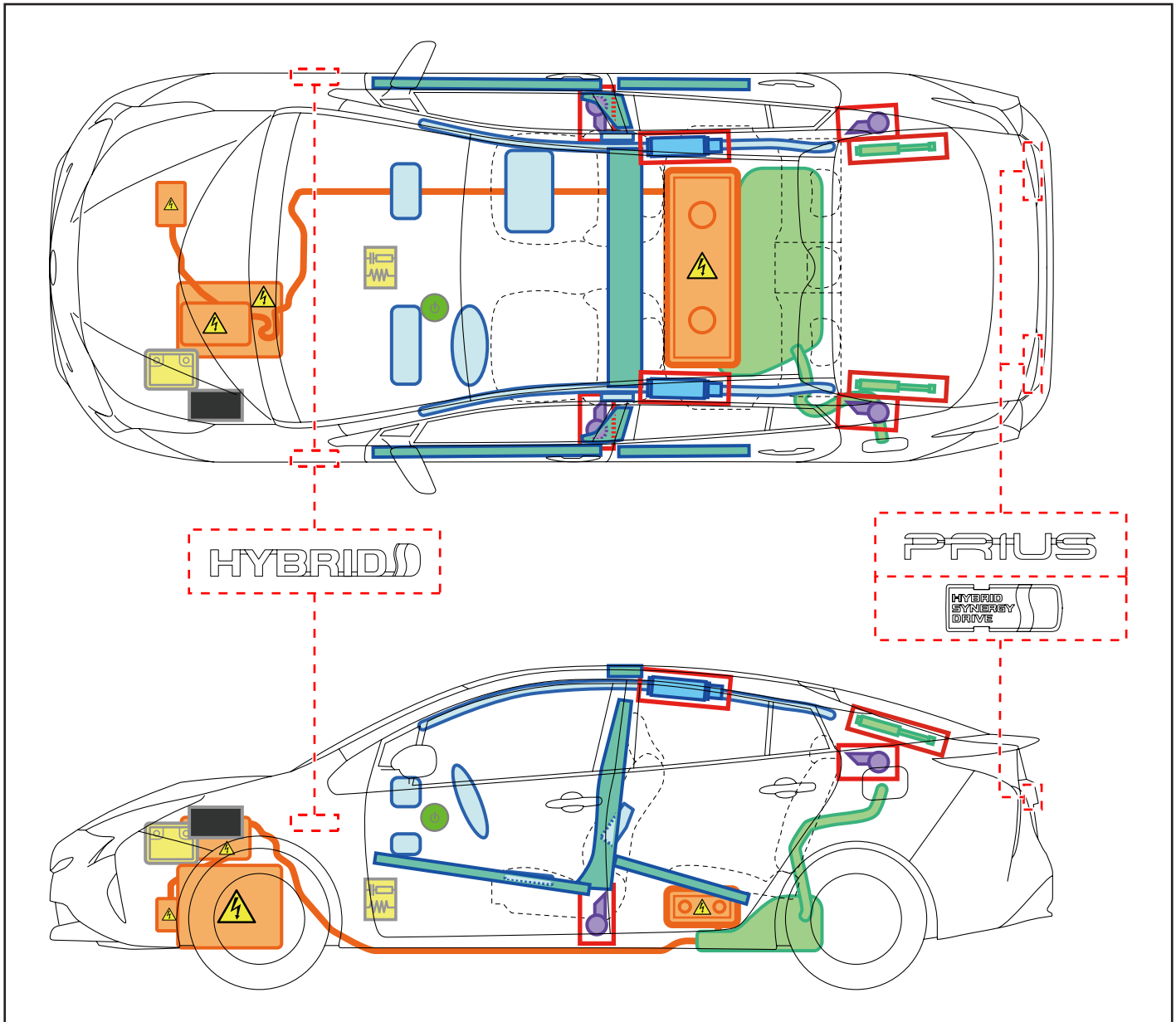

	Wyłącznik zapłonu/ Przycisk rozruchu		Skrzynka bezpieczników		Akumulator 12V
	Poduszka powietrzna (w tym napełniacz)		Generator gazu		Akumulator wysokonapięciowy
	Obwód wysokiego napięcia		Zbiornik paliwa		Sprężyna gazowa
	Napinacz pasa bezpieczeństwa		Wzmocnienie nadwozia		Sterownik
-	-	-	-	-	-

Zabezpieczenie pojazdu

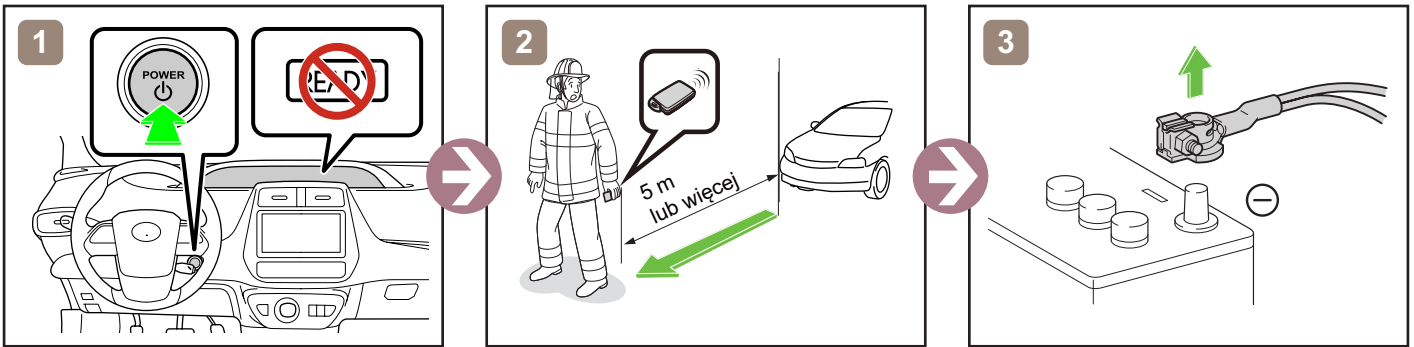

lub

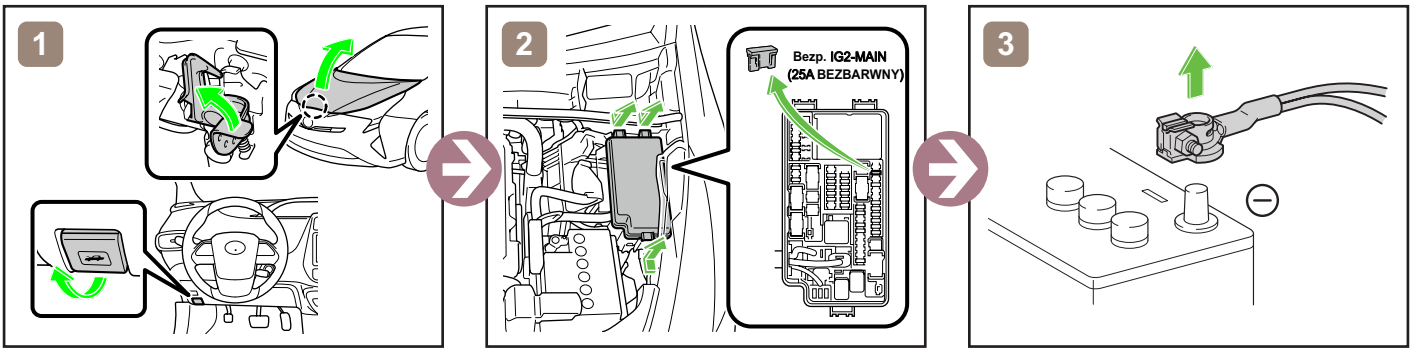

Dostęp do akumulatora 12V

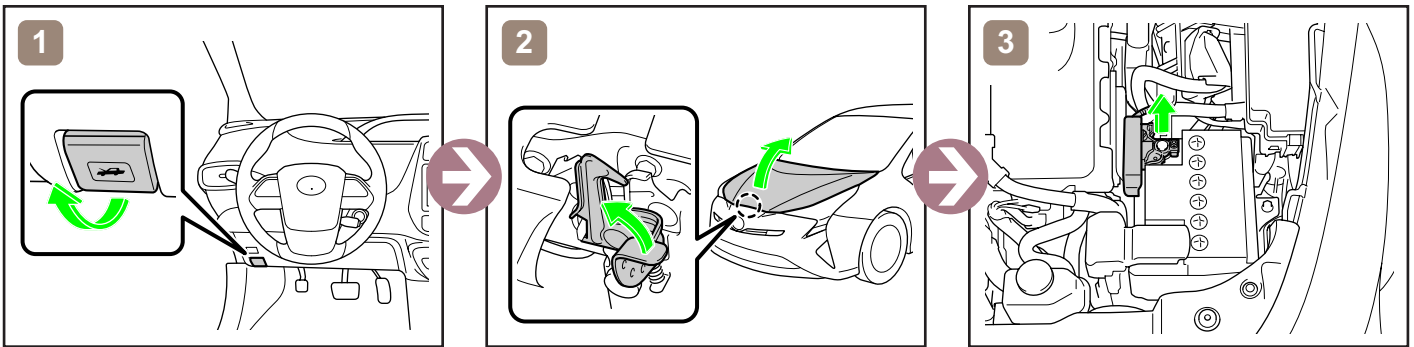

Holowanie pojazdu

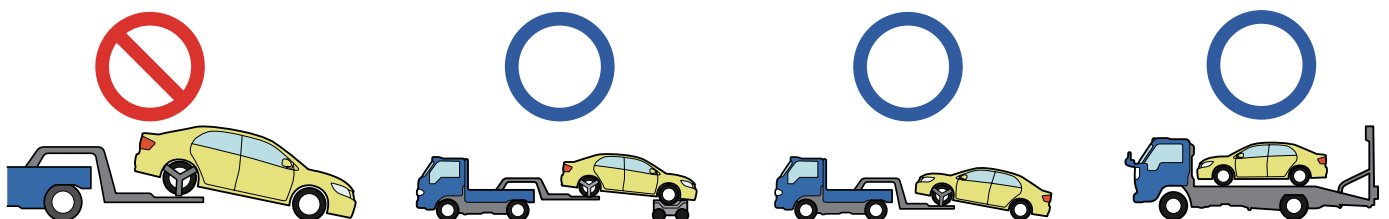

PRIUS PRIME/ PRIUS PHV

LHD

2016-9

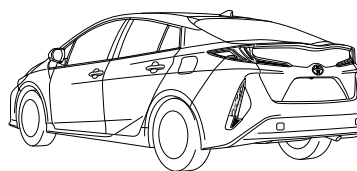
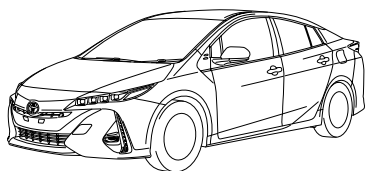

TOYOTA

PLUG-IN
HYBRID

HV BATTERY
Li-ion

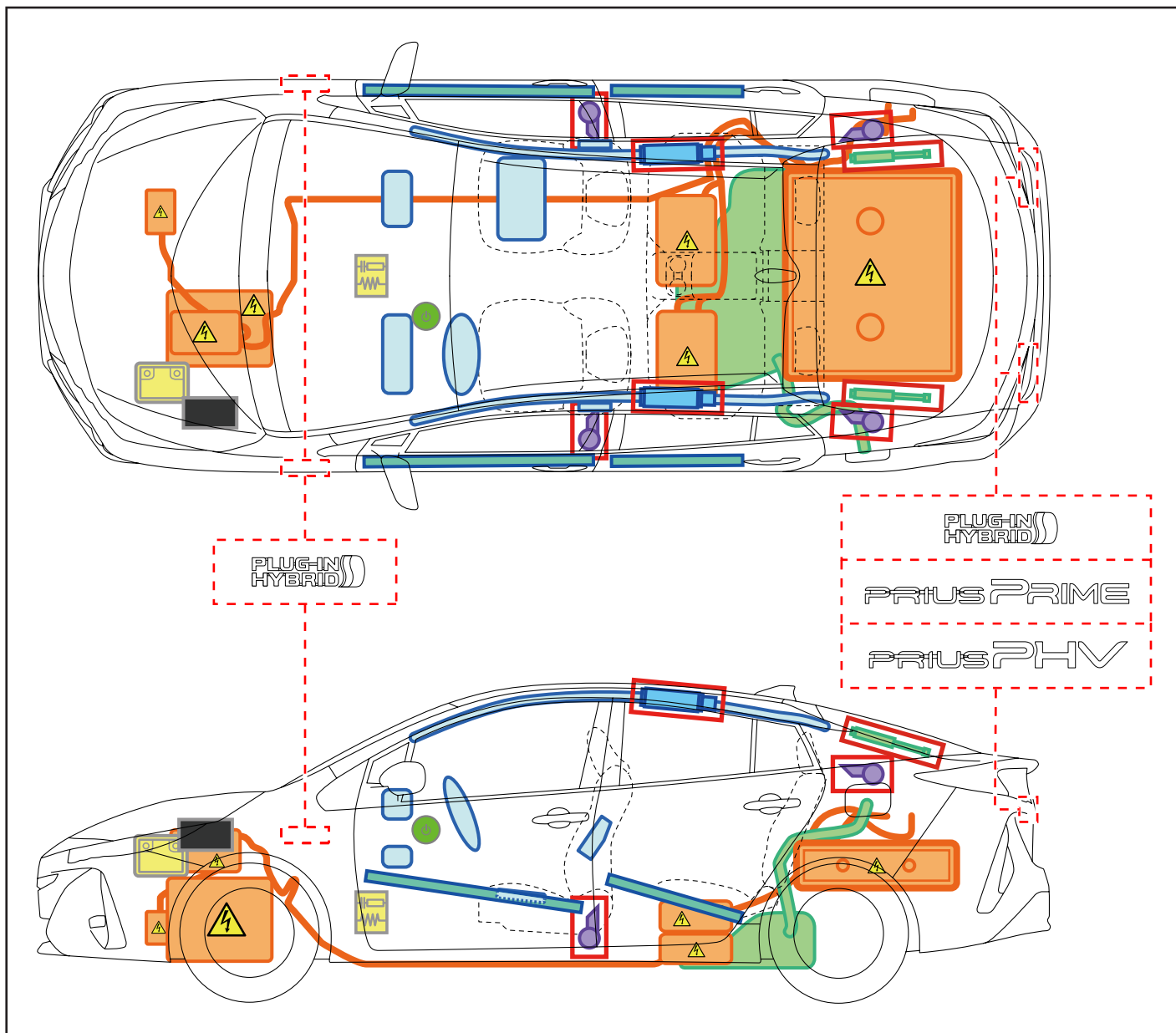

	Wyłącznik zapłonu/ Przycisk rozruchu		Skrzynka bezpieczników		Akumulator 12V
	Poduszka powietrzna (w tym napełniacz)		Generator gazu		Akumulator wysokonapięciowy
	Obwód wysokiego napięcia		Zbiornik paliwa		Sprężyna gazowa
	Napinacz pasa bezpieczeństwa		Wzmocnienie nadwozia		Sterownik
-	-	-	-	-	-

Zabezpieczenie pojazdu

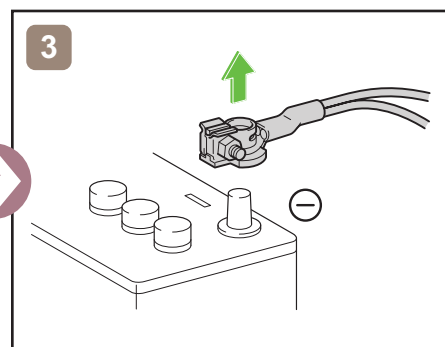
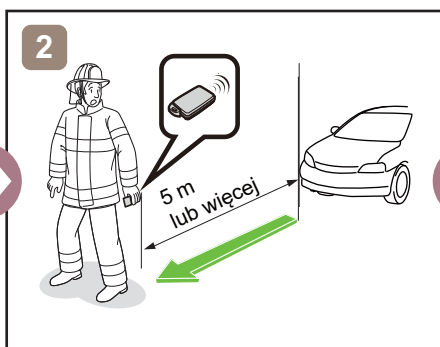
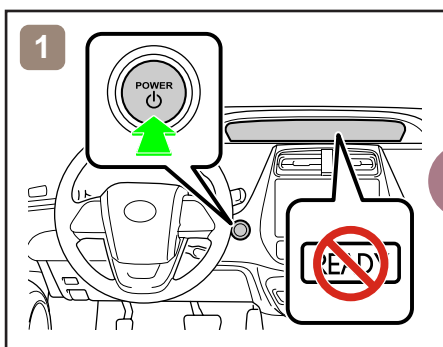

lub

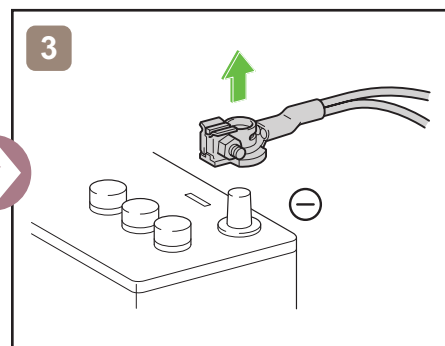
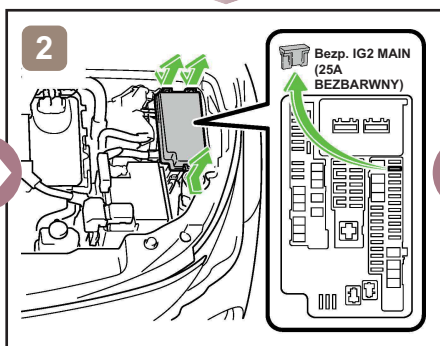
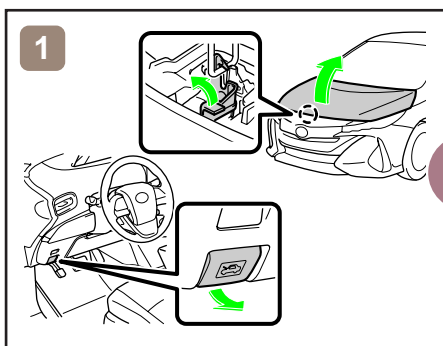

Dostęp do akumulatora 12V

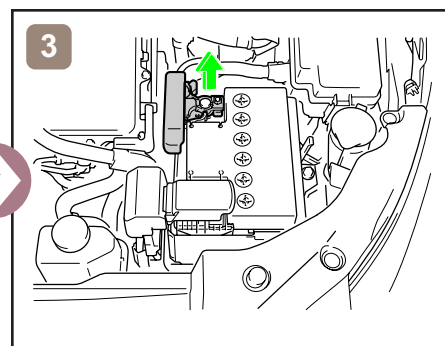
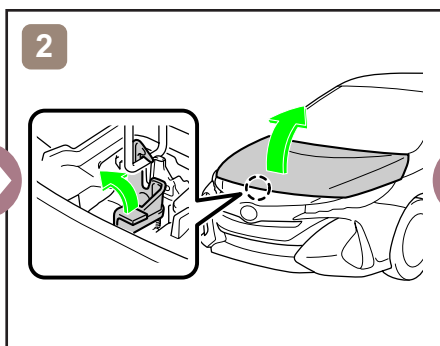
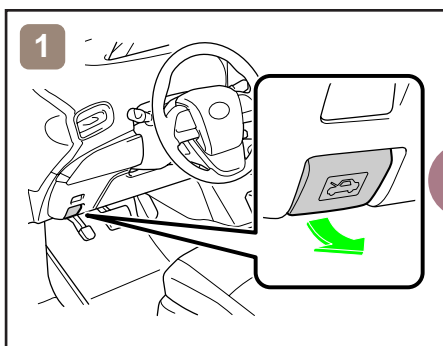

Holowanie pojazdu

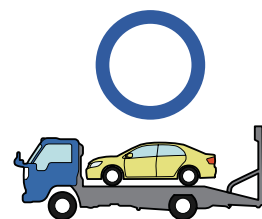
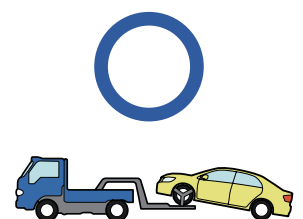
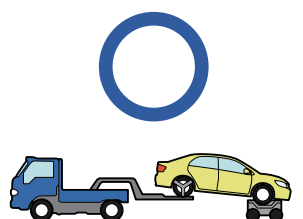
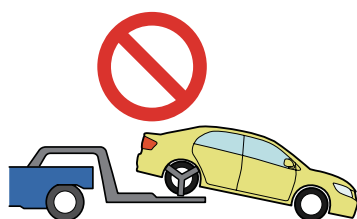









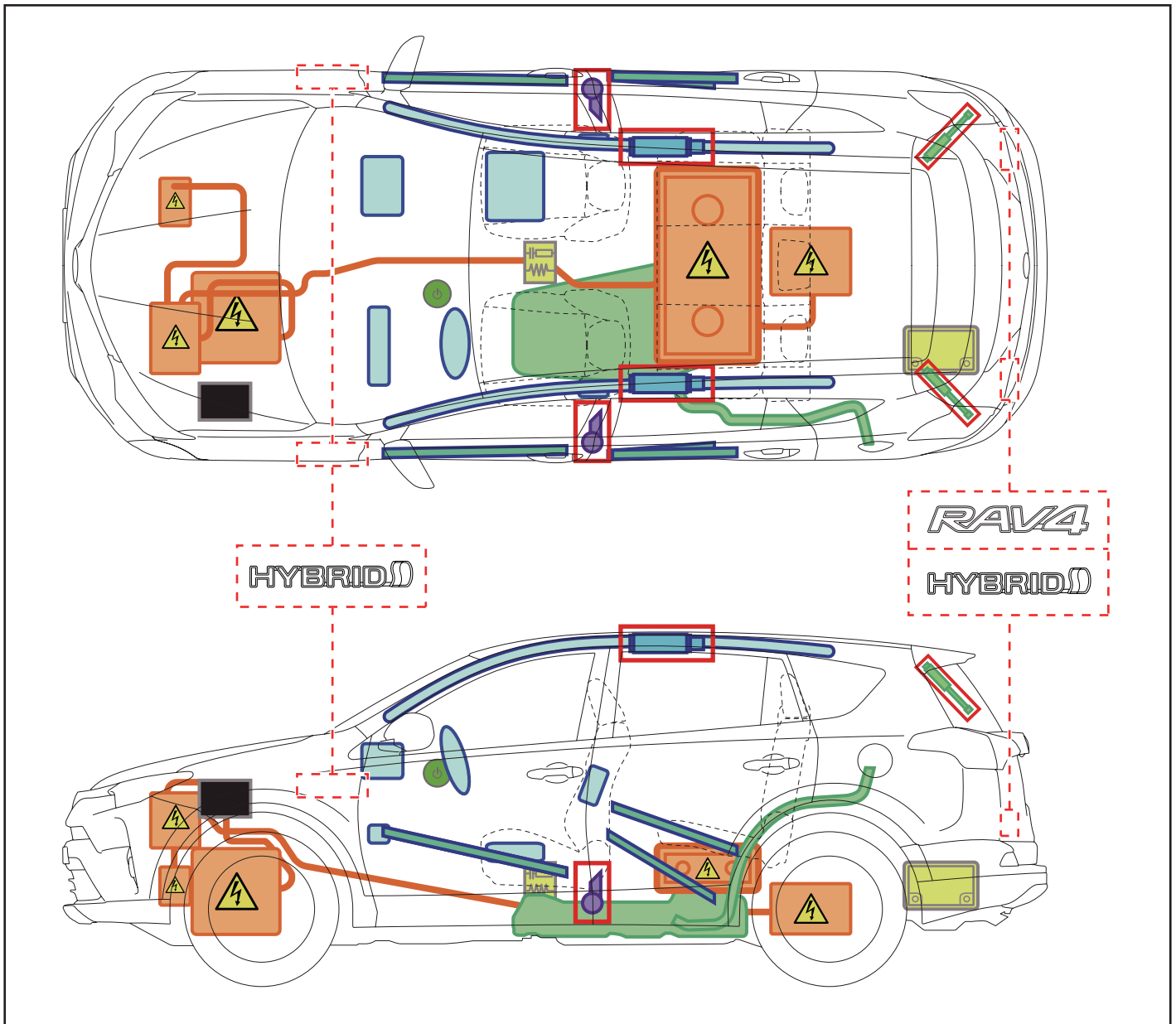



RAV4

HYBRID

LHD

2015-10



	Wyłącznik zapłonu/ Przycisk rozruchu		Skrzynka bezpieczników		Akumulator 12V
	Poduszka powietrzna (w tym napełniacz)		Generator gazu		Akumulator wysokonapięciowy
	Obwód wysokiego napięcia		Zbiornik paliwa		Sprężyna gazowa
	Napinacz pasa bezpieczeństwa		Wzmocnienie nadwozia		Sterownik
—	—	—	—	—	—

Zabezpieczenie pojazdu

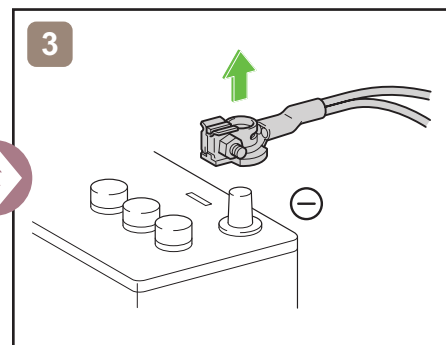
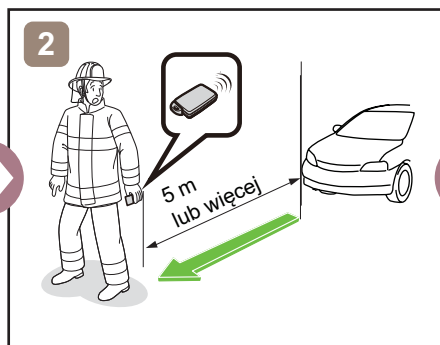
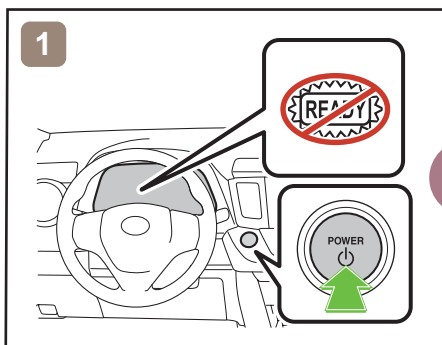

lub

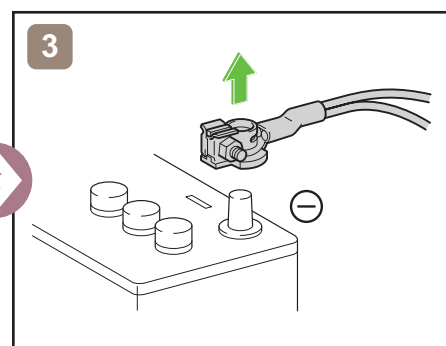
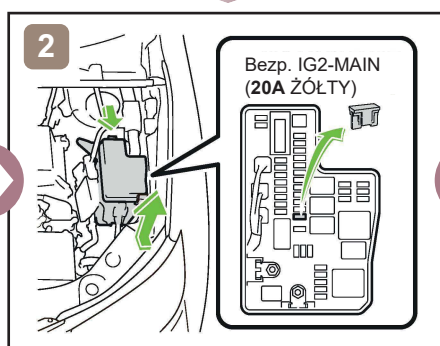
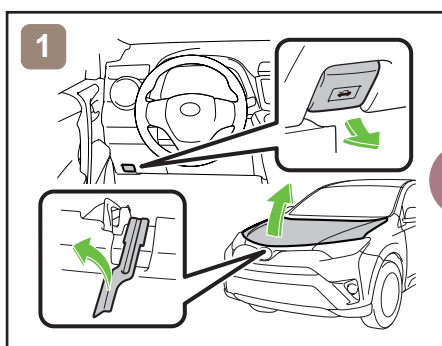

Dostęp do akumulatora 12V

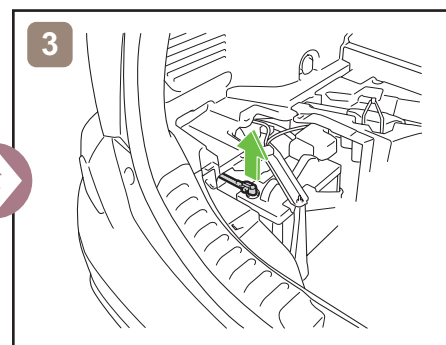
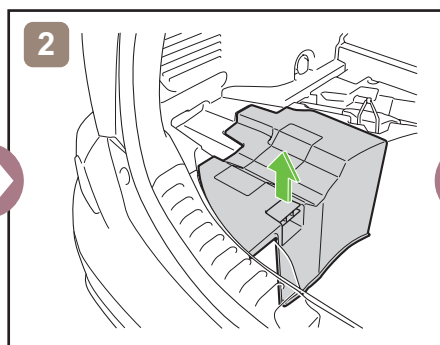
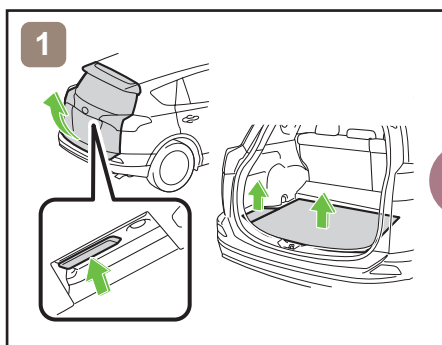

Holowanie pojazdu











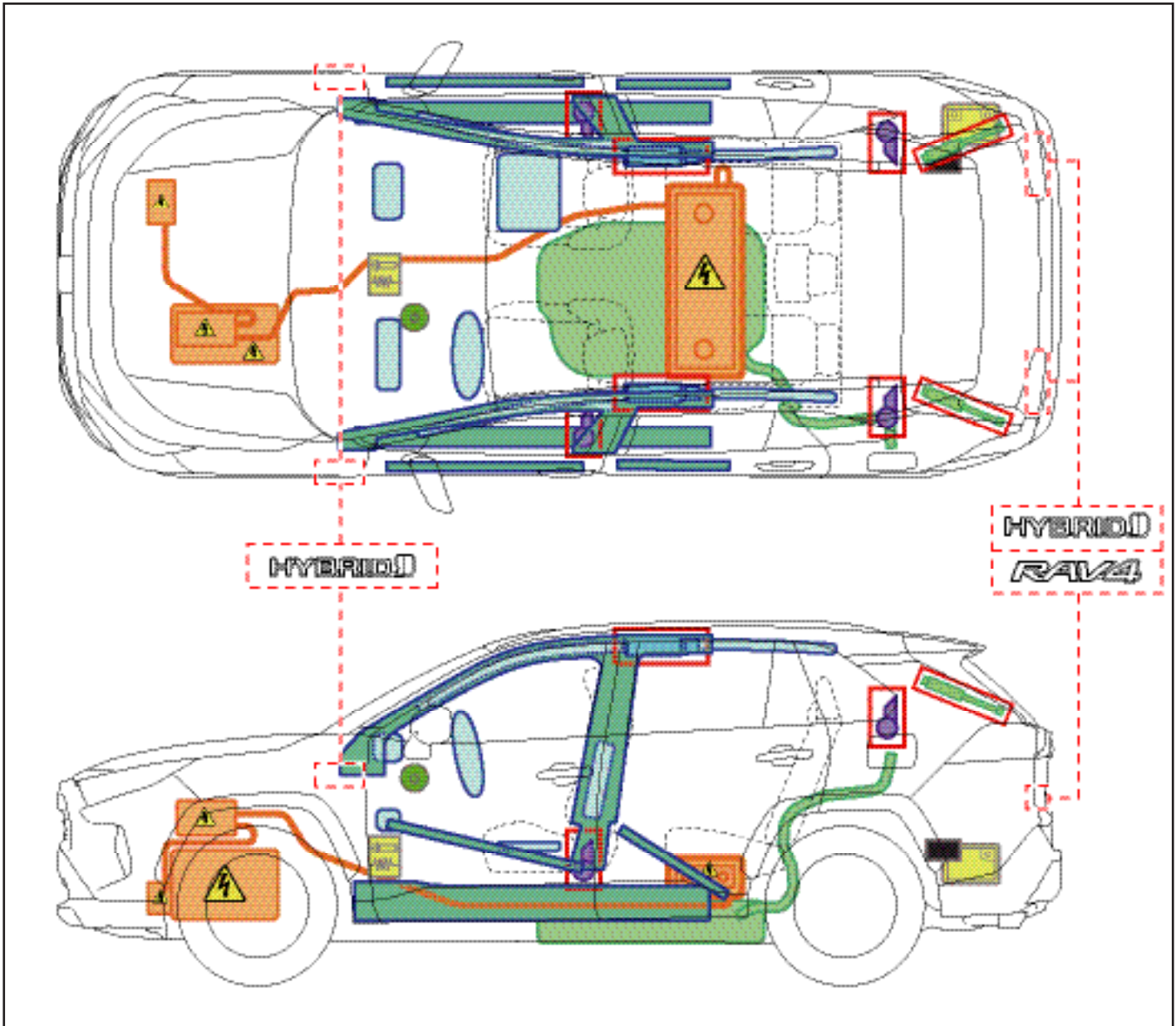



RAV4

HYBRID

LHD

2018-11



	Wyłącznik zapłonu/ Przycisk rozruchu		Skrzynka bezpieczników		Akumulator 12V
	Poduszka powietrzna (w tym napełniacz)		Generator gazu		Akumulator wysokonapięciowy
	Obwód wysokiego napięcia		Zbiornik paliwa		Sprężyna gazowa
	Napinacz pasa bezpieczeństwa		Wzmocnienie nadwozia		Sterownik
—	—	—	—	—	—

Zabezpieczenie pojazdu

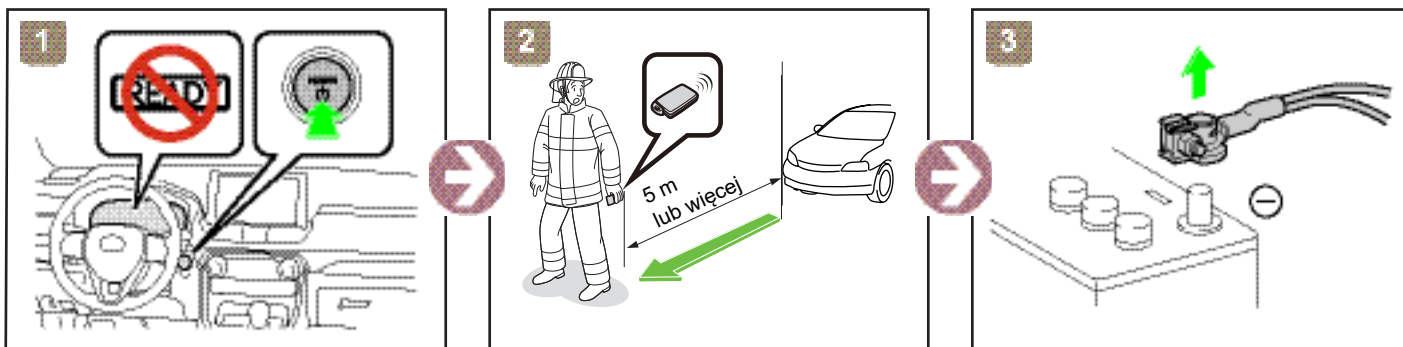

lub

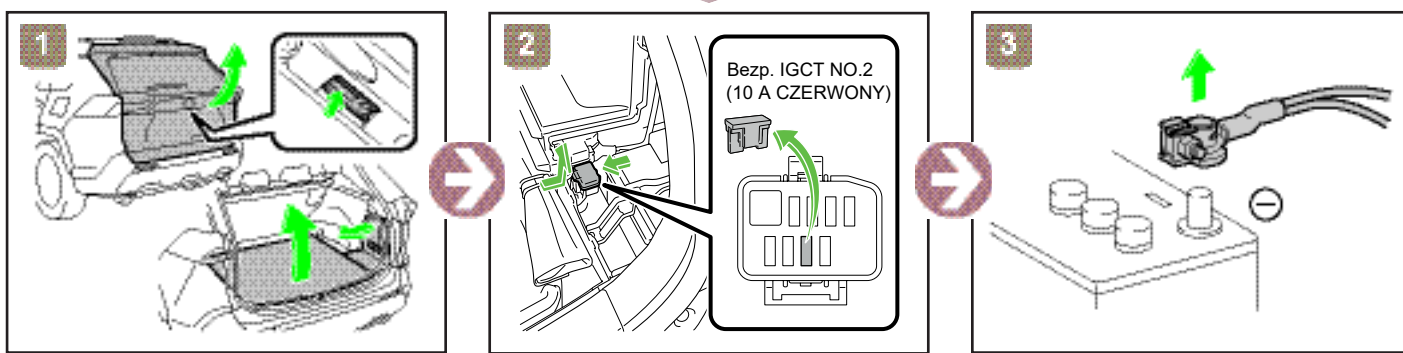

Dostęp do akumulatora 12V

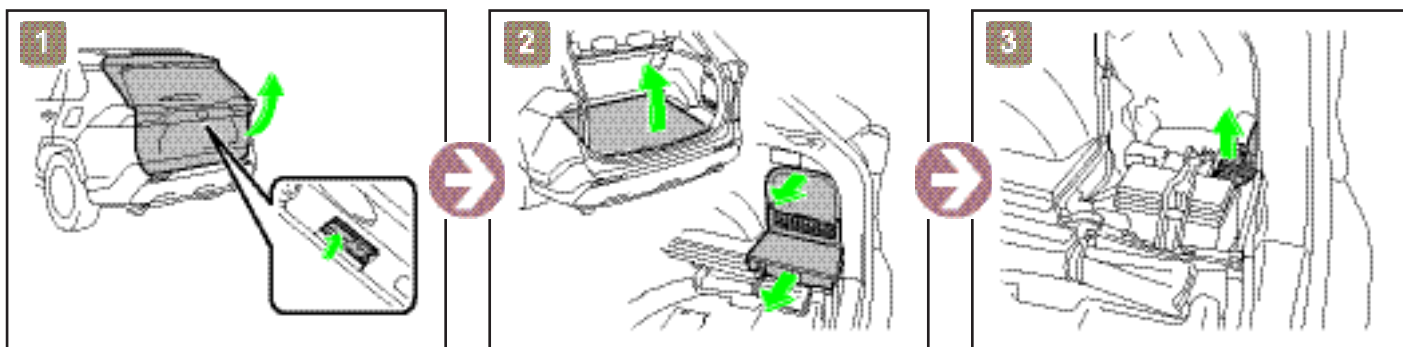

Holowanie pojazdu









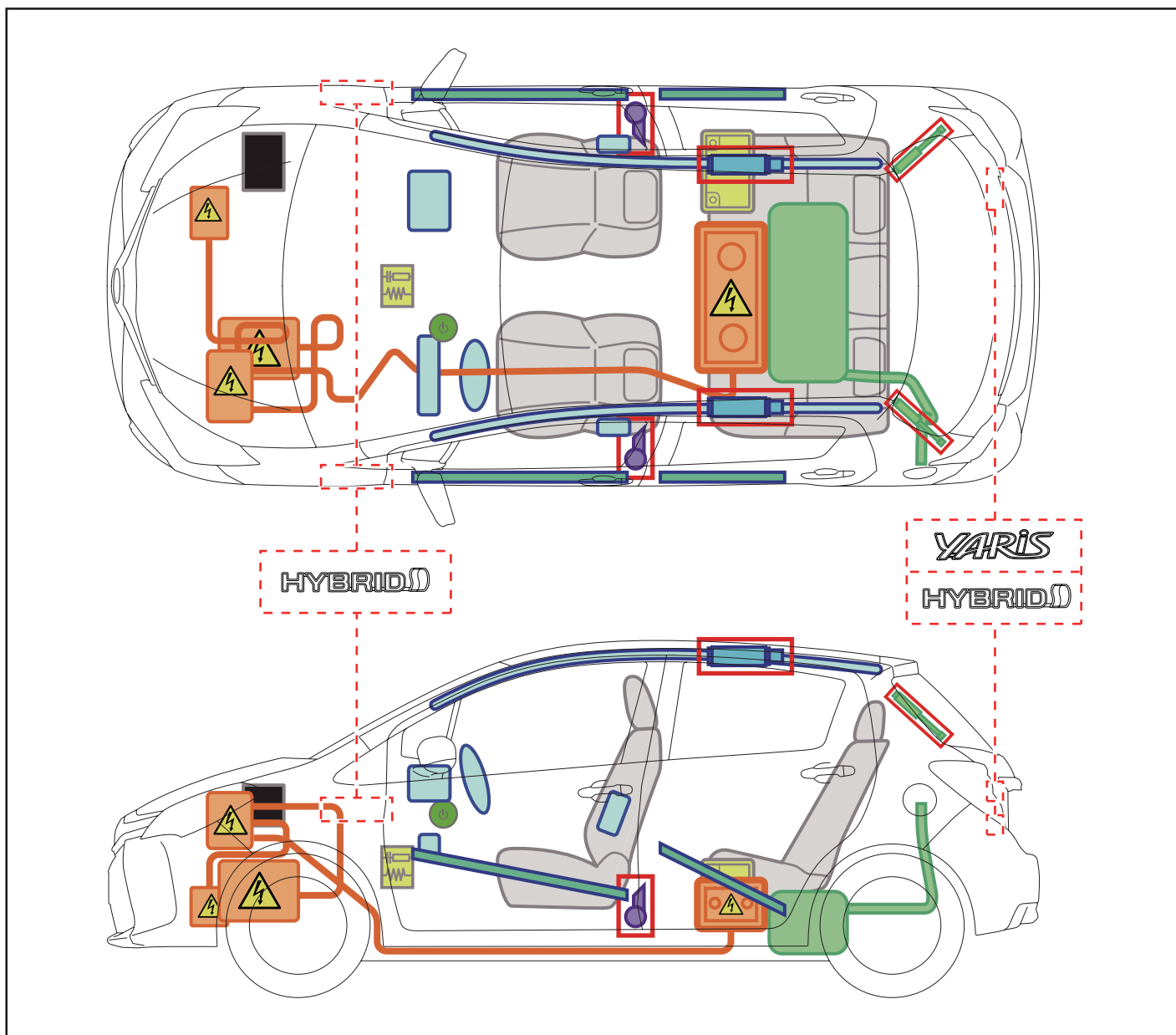
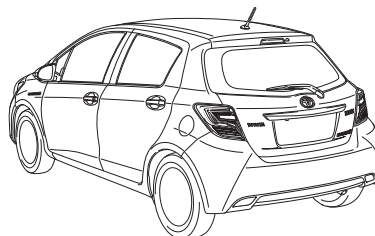
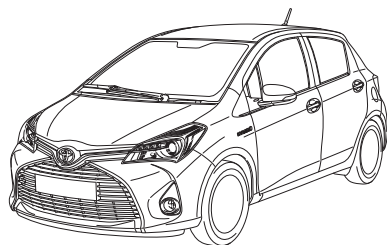





YARIS

HYBRID / LHD

2014-7



	Wyłącznik zapłonu/ Przycisk rozruchu		Skrzynka bezpieczników		Akumulator 12V
	Poduszka powietrzna (w tym napełniacz)		Generator gazu		Akumulator wysokonapięciowy
	Obwód wysokiego napięcia		Zbiornik paliwa		Sprężyna gazowa
	Napinacz pasa bezpieczeństwa		Wzmocnienie nadwozia		Sterownik
—	—	—	—	—	—

Zabezpieczenie pojazdu

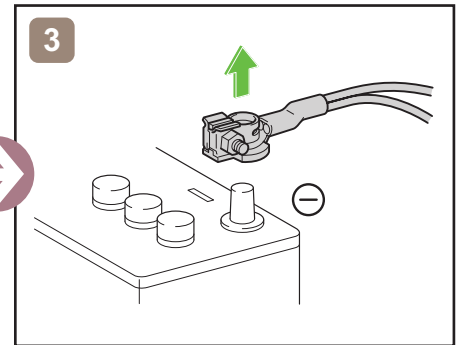
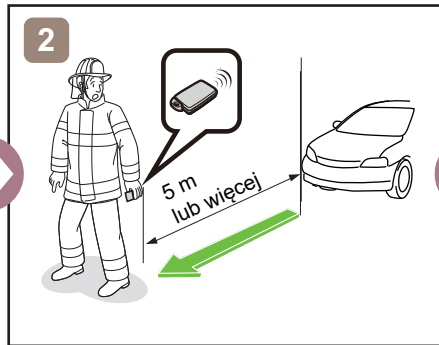
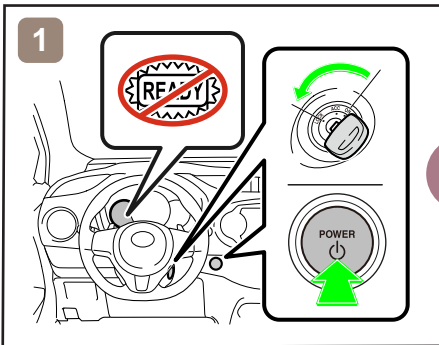

lub

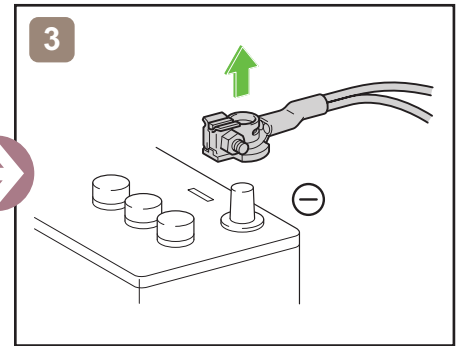
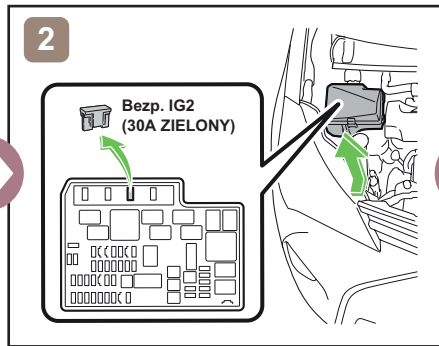
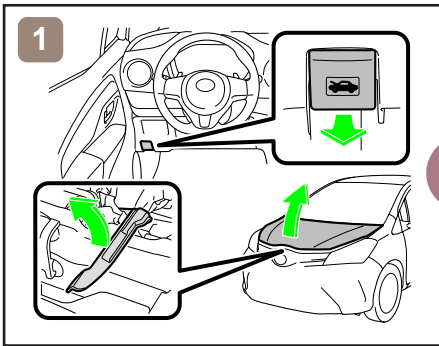

Dostęp do akumulatora 12V

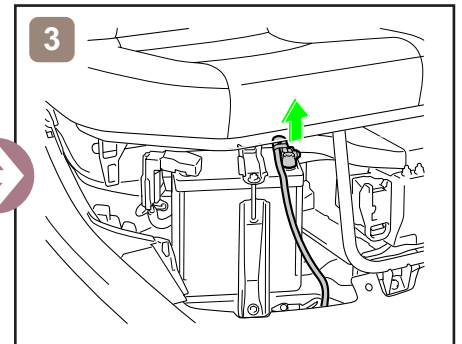
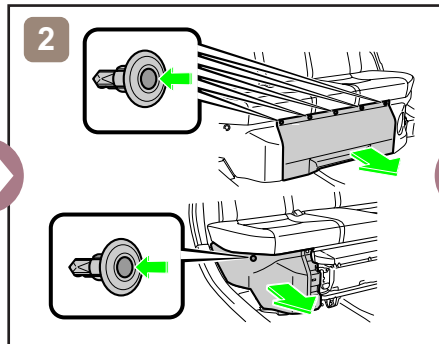
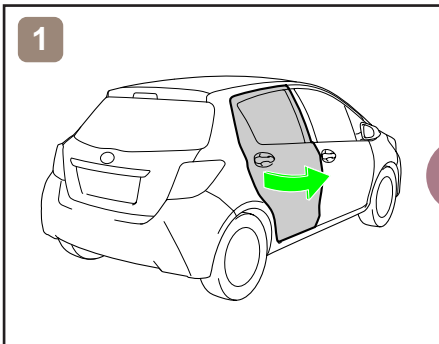

Holowanie pojazdu

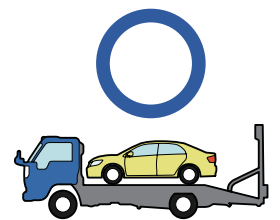
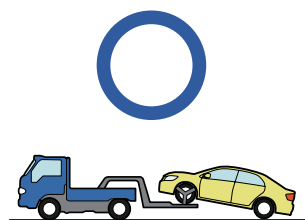
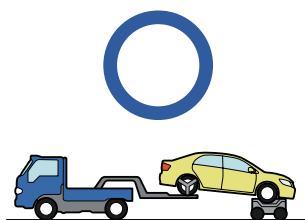
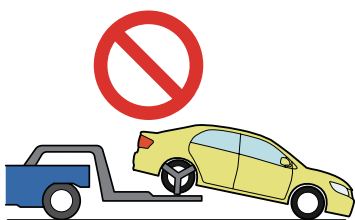









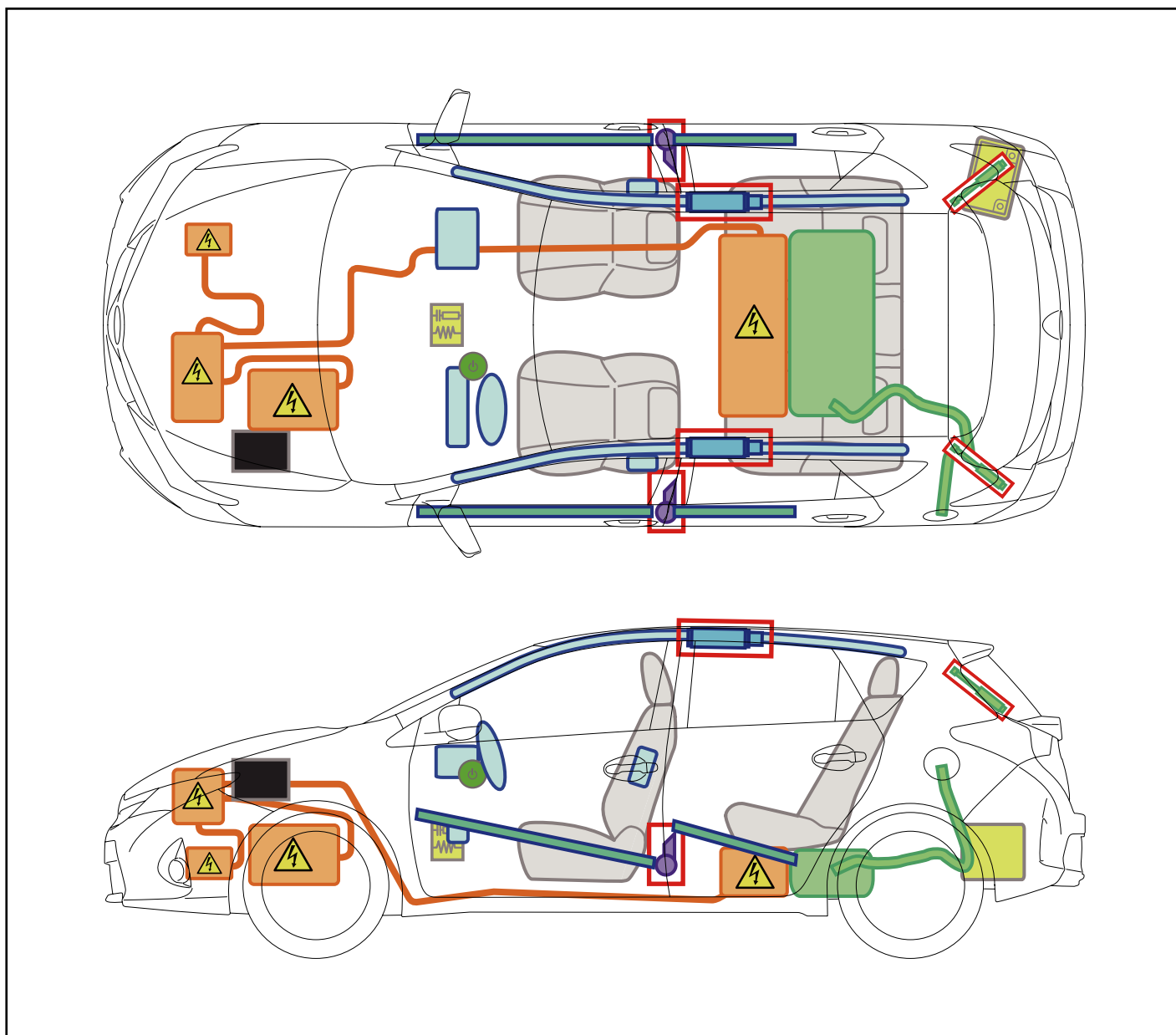



AURIS

HYBRID

HATCHBACK / LHD

2013-6



	Przycisk rozruchu		Skrzynka bezpieczników		Akumulator 12V
	Poduszka powietrzna		Generator gazu		Obwód wysokiego napięcia
	Zbiornik paliwa		Sprężyna gazowa		Napinacz pasa bezpieczeństwa
	Wzmocnienie nadwozia		Sterownik	—	—
—	—	—	—	—	—

Zabezpieczenie pojazdu

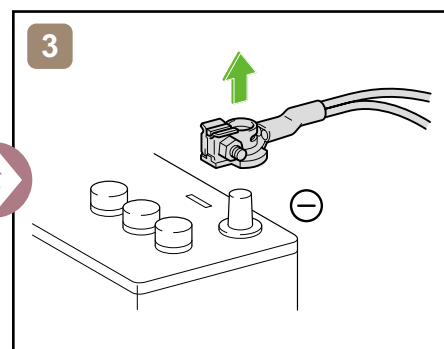
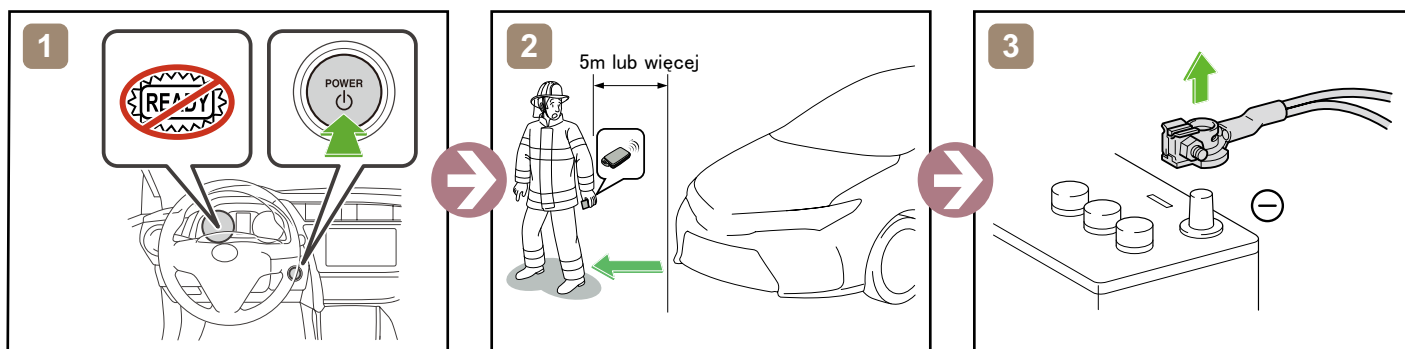

lub

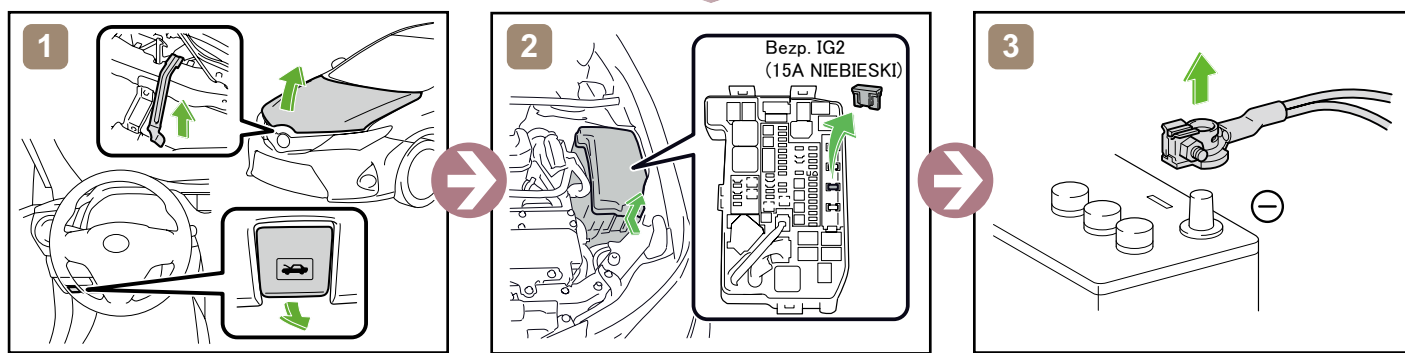

Dostęp do akumulatora 12V

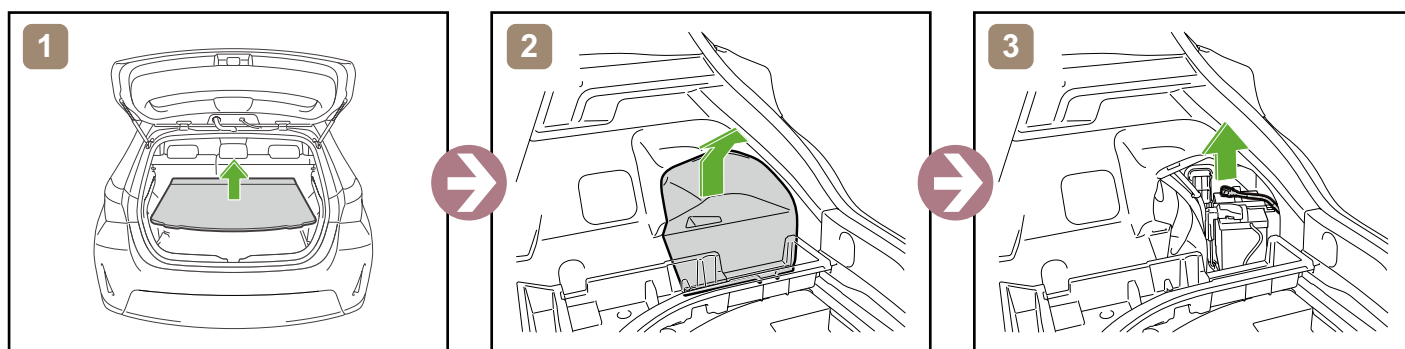

Holowanie pojazdu

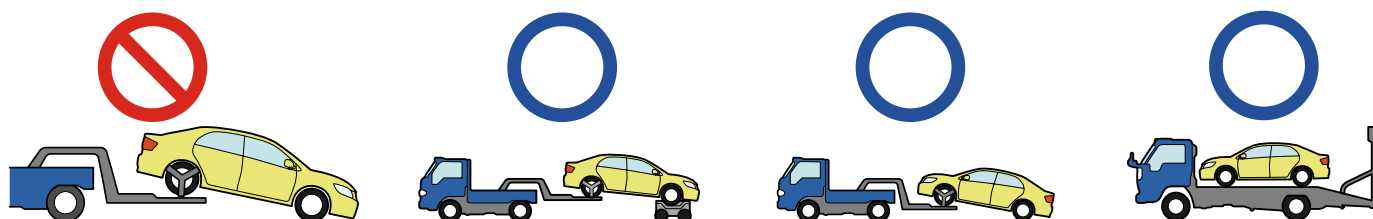

AURIS

HYBRID
WAGON / LHD
2013-6

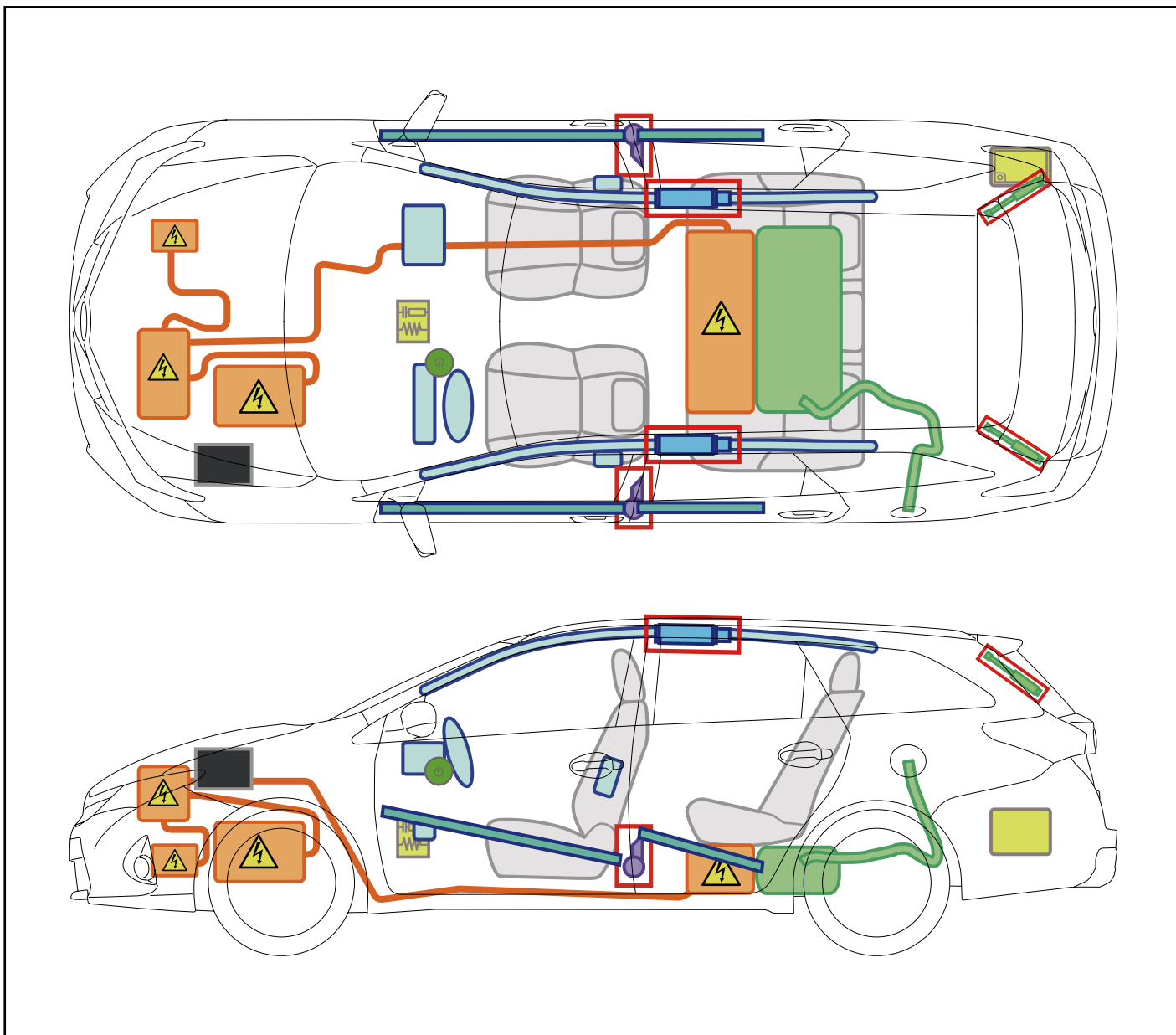

	Przycisk rozruchu		Skrzynka bezpieczników		Akumulator 12V
	Poduszka powietrzna		Generator gazu		Obwód wysokiego napięcia
	Zbiornik paliwa		Sprężyna gazowa		Napinacz pasa bezpieczeństwa
	Wzmocnienie nadwozia		Sterownik	—	—
—	—	—	—	—	—

Zabezpieczenie pojazdu

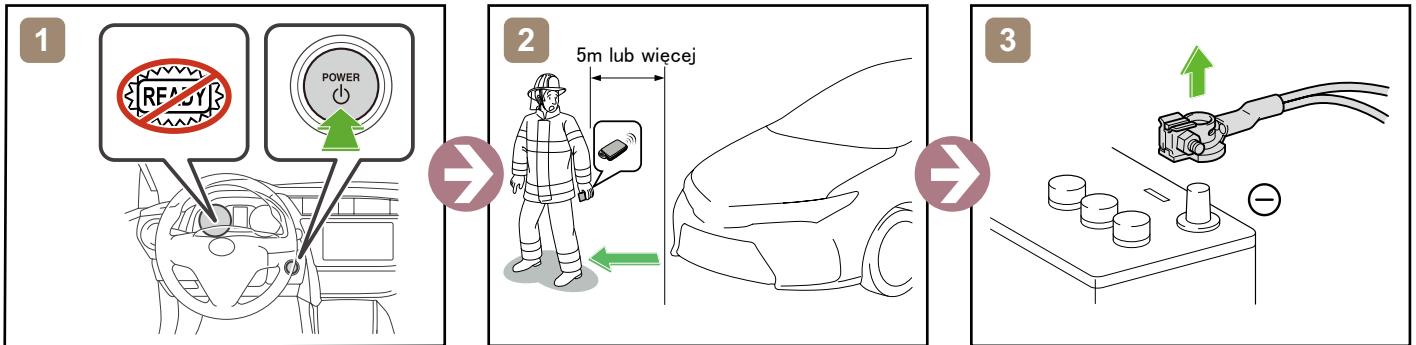

lub

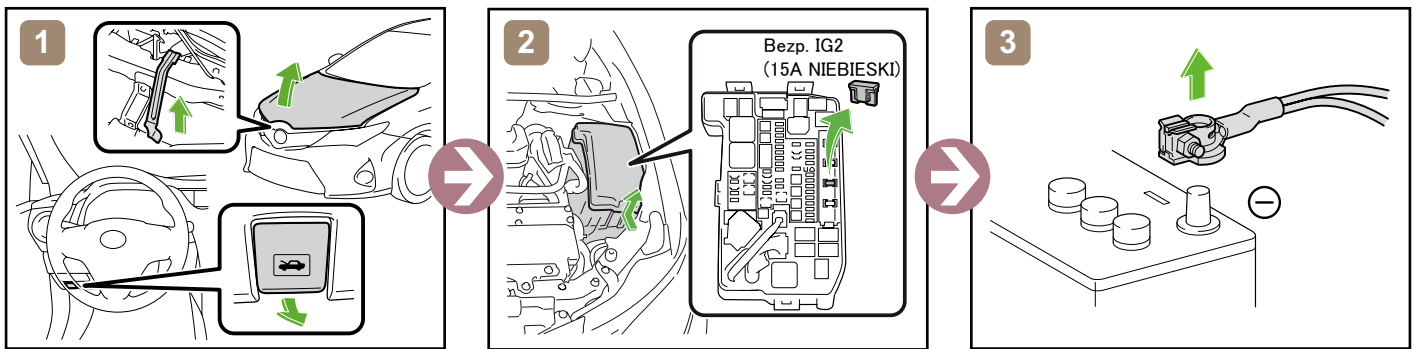

Dostęp do akumulatora 12V

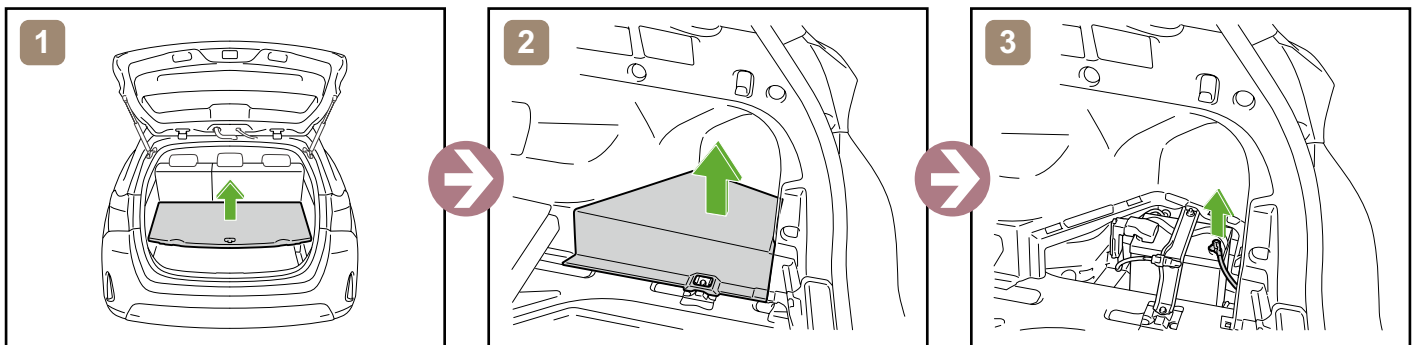

Holowanie pojazdu

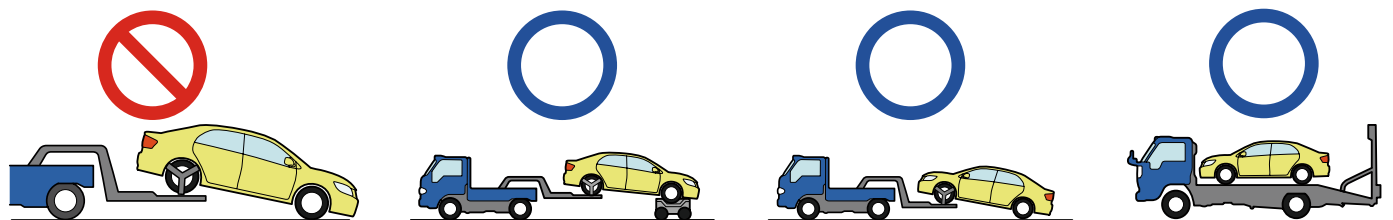

CAMRY HYBRID

LHD

2017-7

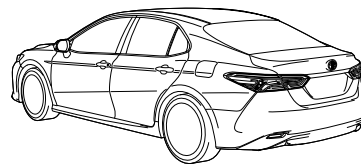
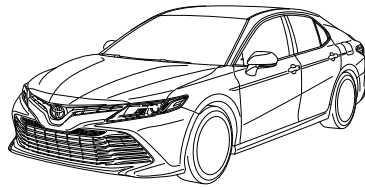

TOYOTA



HV BATTERY
Ni-MH

HV BATTERY
Li-ion

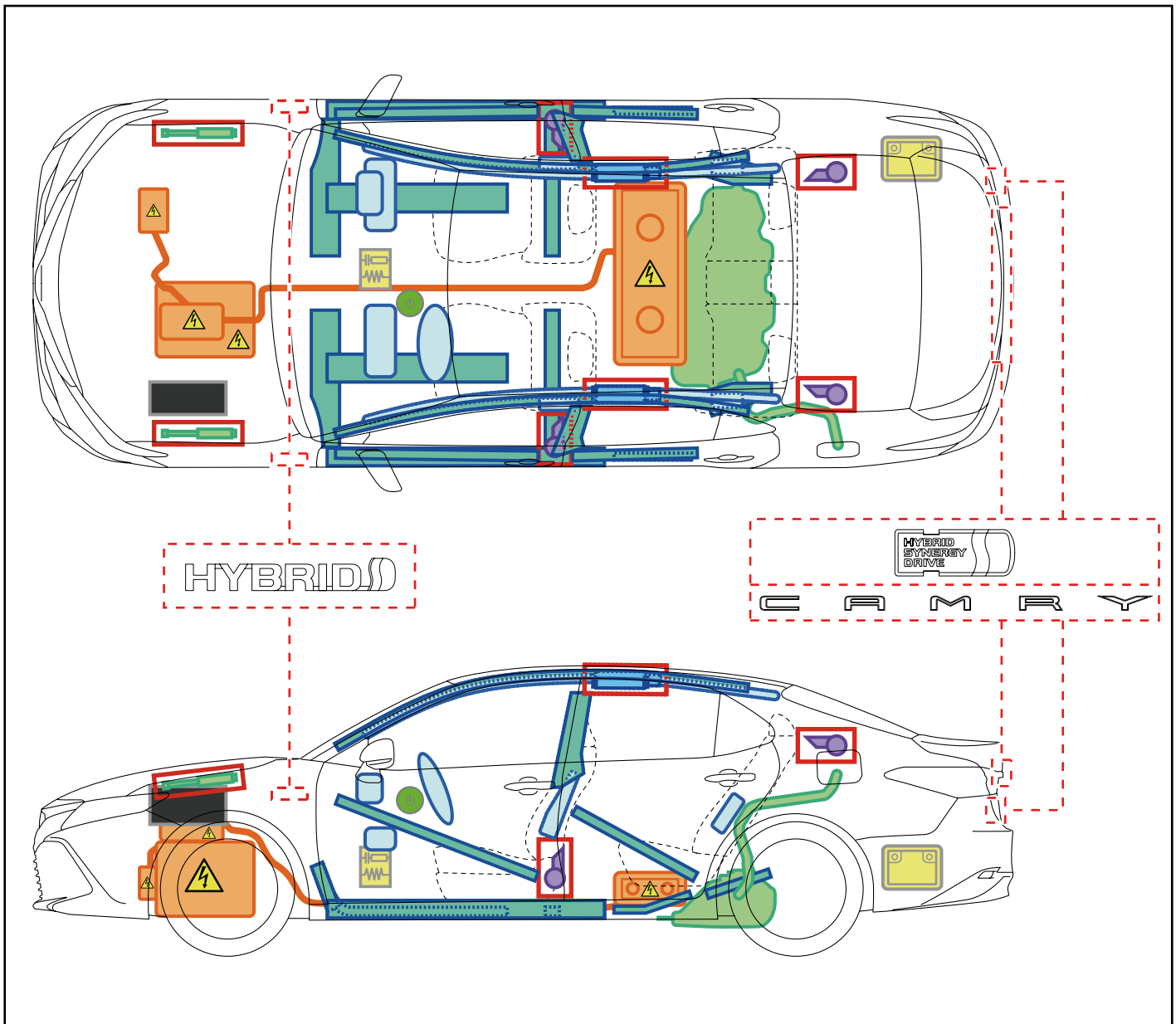

	Wyłącznik zapłonu/ Przycisk rozruchu		Skrzynka bezpieczników		Akumulator 12V
	Poduszka powietrzna (w tym napełniacz)		Generator gazu		Akumulator wysokonapięciowy
	Obwód wysokiego napięcia		Zbiornik paliwa		Sprężyna gazowa
	Napinacz pasa bezpieczeństwa		Wzmocnienie nadwozia		Sterownik
-	-	-	-	-	-

Zabezpieczenie pojazdu

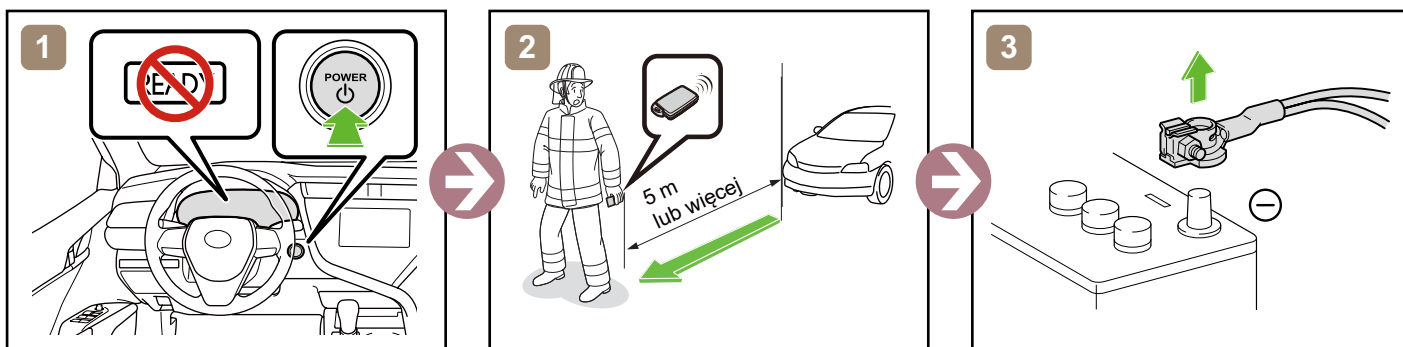

lub

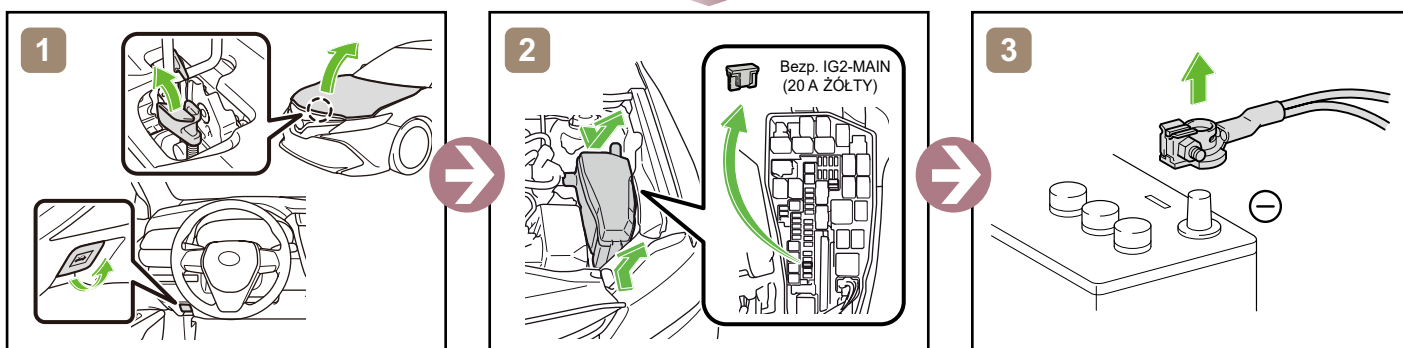

Dostęp do akumulatora 12V

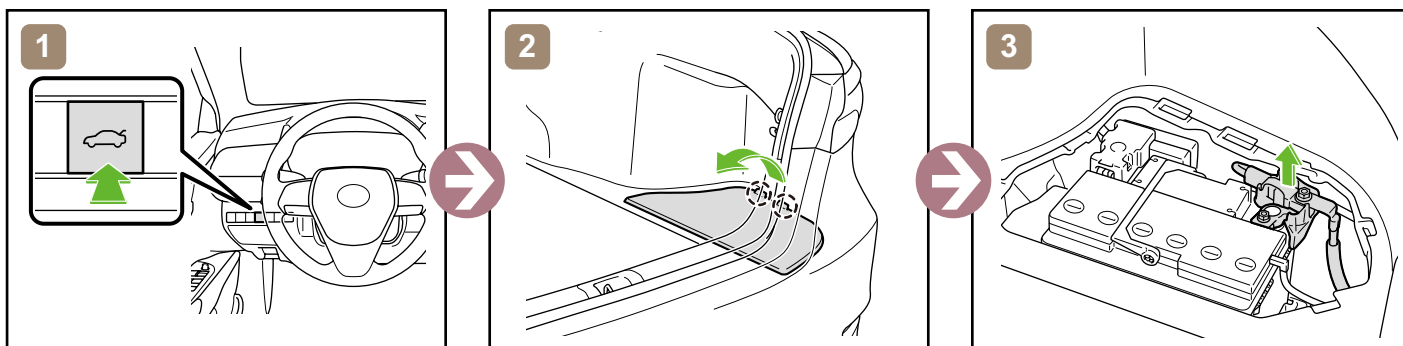

Holowanie pojazdu

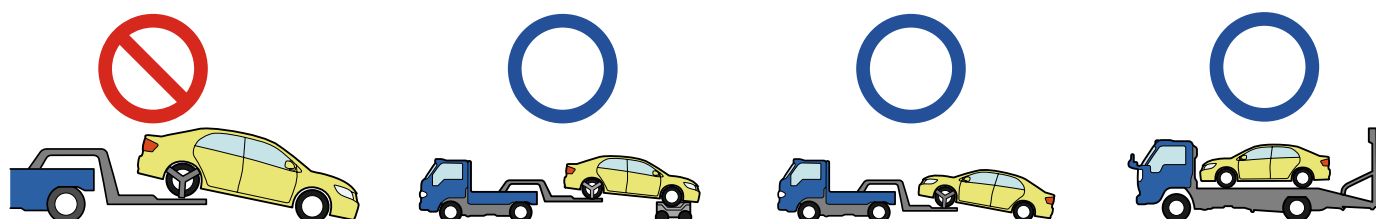

C-HR HYBRID

LHD

2016-10

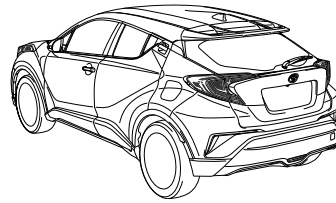
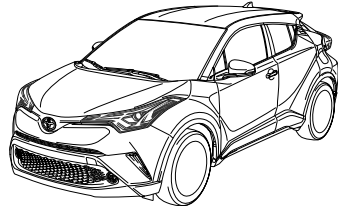

TOYOTA

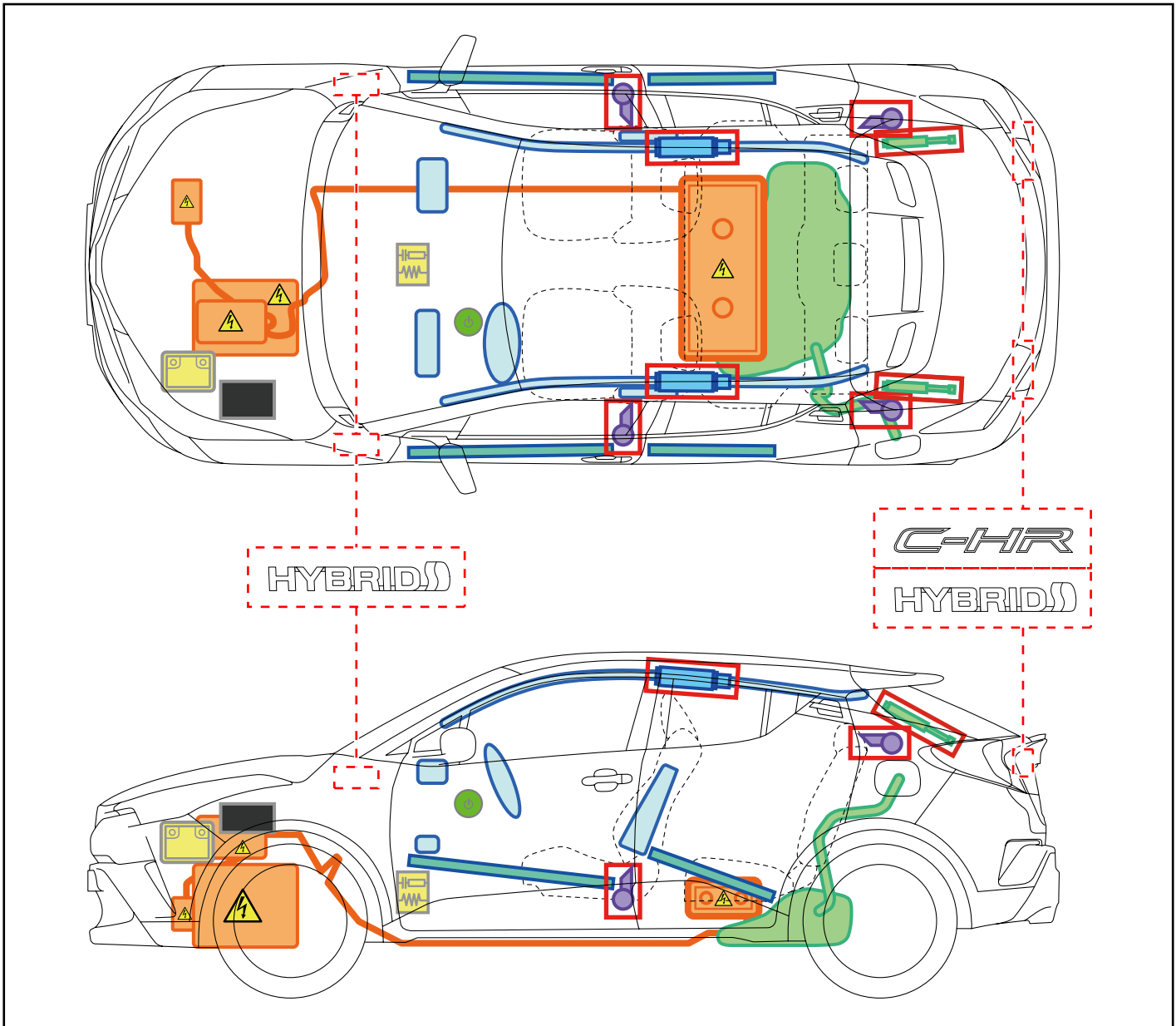

HYBRID

C-HR
HYBRID

	Wyłącznik zapłonu/ Przycisk rozruchu		Skrzynka bezpieczników		Akumulator 12V
	Poduszka powietrzna (w tym napełniacz)		Generator gazu		Akumulator wysokonapięciowy
	Obwód wysokiego napięcia		Zbiornik paliwa		Sprężyna gazowa
	Napinacz pasa bezpieczeństwa		Wzmocnienie nadwozia		Sterownik
-	-	-	-	-	-

Zabezpieczenie pojazdu

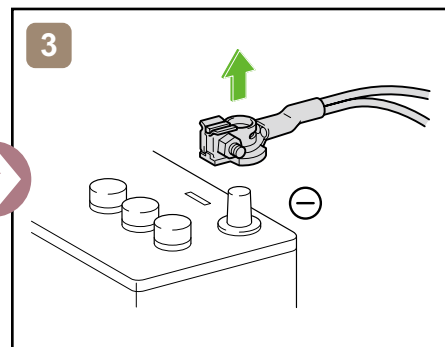
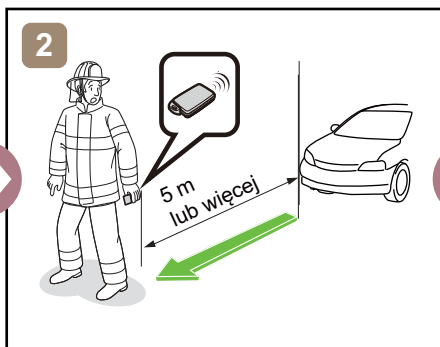
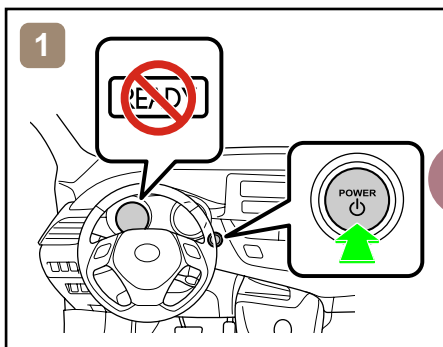

lub

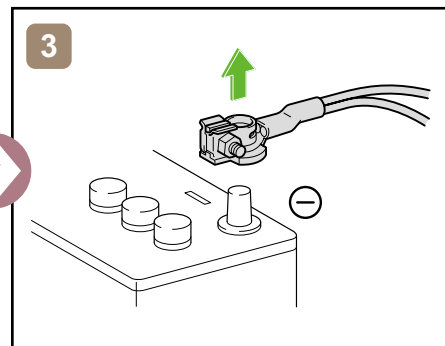
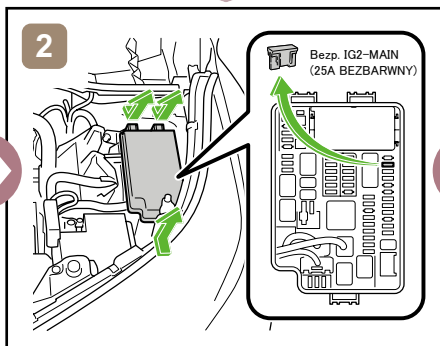
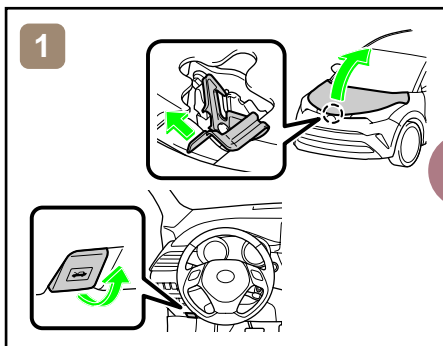

Dostęp do akumulatora 12V

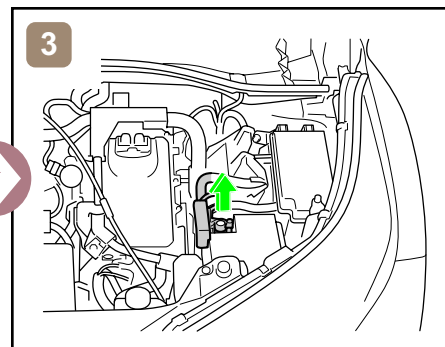
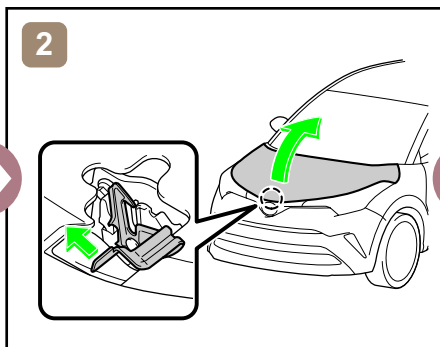
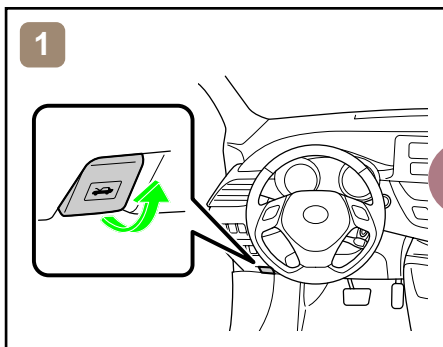

Holowanie pojazdu

